

TT

185

S45

**WOODWORK
FOR THE
GRADES**

FRANK HENRY SELDEN



Class TT185

Book S45





Woodwork for the Grades

FOR USE IN

Manual Training Classes

BY

FRANK HENRY SELDEN

Director of the Department of Mechanical Science, State Normal School
Valley City, North Dakota

Author of the "Selden Series" of
Texts for Elementary Schools,
High Schools, Technical Schools

Fully Illustrated from Actual Shop Practice



THE MAUDSLAY PRESS
VALLEY CITY, NORTH DAKOTA

TT185
'S45

COPYRIGHTED BY
ORR & LOCKETT HARDWARE Co., 1908
FRANK HENRY SELDEN, 1912

12-14171

Publisher's Note

It is more than three years since the first pages of this text were printed. At once they found a place in the school shop that demonstrated the wisdom of the publishers in supplying a definite text to be studied and depended upon as the basis of instruction for work in the wood shop.

So fully has the value of a definite text in the hands of the pupil been demonstrated that it appears to be advisable to place before the teachers and pupils a complete series of texts in harmony with the principles of Mechanical Science. To accomplish this, a somewhat large undertaking, the future publication of these works will be in the hands of the author thru a business organized under the name of the first student and teacher of Mechanical Science, Henry Maudslay, in whose shops Whitworth, Clement, Naysmith and other eminent mechanics received the early training that made possible their large contributions to the beginnings of modern methods of working solid materials.

It will ever be the aim of the publishers to keep the books fully up to the practice of the best schools. An exceptional amount of expense has been incurred in procuring the illustrations, all of which, except a few of those of tools are entirely original. This statement appears to be necessary because of several other publishers making use of cuts taken from this author's texts.

FRANK HENRY SELDEN.



Woodwork for the Grades

Introduction

This course in woodwork is intended for use by pupils who have had no previous experience with wood-working tools.

It is planned to develop the subject in a systematic manner in harmony with well established pedagogic principles.

The lessons consist of instruction in tool usage, followed by a large variety of designs for articles useful in the home. The first lessons should be thoroughly mastered so that the interest and progress in construction will be genuine and of educational value. It is no waste of time or interest to learn by use of study pieces the fundamental tool operations. Such a plan if properly followed will result not only in far larger educational value, but also in deeper interest and a better display of finished articles.

The advantages of using a complete, definite text are beyond the belief of those teachers of shop work who depend upon oral instruction or the use of reference works. The use of this text has not only demonstrated the advisability of using a text as a matter of economy of the teacher's time, but has also demonstrated that with this text the pupils will accomplish as much in the sixth grade as we have heretofore without this aid expected of the eighth grade; while in the eighth grade as much value is received as by other means could be gained in first year high school.

NAILS

There are many kinds of nails, brads and similar fastenings. These include common wire nails, cut nails and brads.

To introduce to you all of the styles and sizes at once would only confuse and do more harm than good. The way to gain a proper knowledge of these common and useful articles is to work with but few sizes until they are familiar, then use them as a basis from which to estimate other sizes.

In your school work you will use 6d wire nails first. Examine these nails carefully. Measure them in all ways and remember the dimensions. You will soon learn to select a 6d nail from an assortment of many sizes.

After you have learned this size you can readily estimate the other common sizes by comparison.

In your first work you are likely to use only 6d, 4d and 3d nails. If you do any work at home with rough inch boards you will likely use 10d nails for the boards and 20d spikes for the 2 inch frame-work which is usually required. By driving a 6d nail through two $\frac{7}{8}$ inch pieces and noting how much the point extends, you will have a useful and easily retained basis of comparison. By driving a 20d spike through two 2 inch pieces you will get another dimension to work from. Try the 10d nail with two thicknesses of rough inch lumber and also a 1-inch and a 2-inch piece.

After you have learned the sizes of the most common nails you should learn to distinguish between nails which are made from the common size of wire and those which are made from smaller sizes.

Boxes are frequently made with nails having a smaller diameter than the common wire nails. Hence nails which are made from wire below the ordinary size are called box nails. A 6d box nail is the same length as a 6d common, but is much lighter and has a smaller head, because the wire from which it is made is smaller.

Nails of very small size are made for small work. The smaller sizes are sold by *length*. They are distinguished from brads by the shape of the heads. The small nails have the same form of head as the larger nails and spikes.

The brads have small round heads. The reason for this difference is that nails are for use where the surface is not to be highly finished and therefore the nailhead may be visible, or it may be *set* below the surface and covered with putty. In setting a nailhead the wood around the head is usually torn so that the surface will not finish to the best advantage.

The small smooth round heads of the brads do not crush the wood so much when they are *set*, and therefore their heads can be covered in a manner to make the holes scarcely noticeable.

Brads are made in several lengths and each length of several sizes of wire. Most hardware dealers have a variety of lengths, but usually not more than one or two sizes of wire of each length. Your first work will require but a limited variety of brads. You will have little if any occasion to use those made of the smaller sizes of wire. As a basis for comparison, learn the size of a common inch brad so that you can pick one from an assortment of brads without measuring it. The $\frac{1}{2}$ inch and 2 inch are other sizes which it is worth while to learn.

The driving of nails and brads is a matter of great import-

ance. One who knows how to use a hammer properly will drive a brad into a bit of hard wood, while one who does not know how will fail.

It is difficult to either show or explain the proper way to drive nails, but if you will watch carefully every time you use a hammer you soon will learn how to drive nails.

In driving nails or brads into hard wood they should be rubbed on soap or grease to cause them to drive without bending.

SCREWS AND THEIR USES

Screws are made in a great variety of shapes and sizes for many purposes. For your first work in wood you will have occasion to use but two kinds. The flat head wood screw

shown in Fig. 1A and the round head wood screw shown in Fig. 1B are sufficient to begin with.



Fig. 1A—Flat Head Screw.

In using a round head wood screw a hole is bored as large as the shank—the part on which there is no thread. This hole should be as deep as the shank is long. At the bottom of this hole is sometimes bored another for the threaded portion of the screw.



Fig. 1B—Round Head Screw.

The form of bit used in boring these holes is shown in Fig. 2A. This is called a gimlet bit. The size of the hole

is determined by several conditions. If the wood is very hard, the hole should be as large as the thickness of the screw at the base of the thread. If the wood is very soft and you are provided with a good screw driver such as is shown in Fig. 2B no hole will be required.



Fig. 2A—Gimlet Bit

You must therefore consider the texture or hardness of the wood in determining the size of bit to use.

Where two pieces are fastened together by screws it is

usual to bore a hole large enough for the shank of the screw through one piece and bore the



Fig. 2B—Screw Driver

hole for the threaded portion in the other piece without regard to length of either part of the screw.

Often, in manufacturing work, the screw is started with a hammer and then finished with a screw driver. This is a good way to insert small screws in soft wood.

In many cases one difficulty is to avoid splitting the pieces, which requires careful planning of the sizes of the holes bored.

If grease, *not oil*, of some kind is used in the holes the screws will insert easier and also hold better. The grease should be placed in the hole rather than on the screw. Soap is often used for this purpose.

A matter which is often overlooked in inserting screws is that if the screw is turned too much it will strip the thread formed in the wood and fail to hold properly. It requires a

good deal of care to turn the screw just enough to cause it to hold the greatest amount.

Small screws, and especially brass ones, may be twisted in two unless a hole of sufficient size is made.

The flat head wood screw is used in the same manner as the round head wood screw except that in hard wood a conical hole is bored to receive the head. The tool used in boring these holes is called a countersink and is shown in Fig. 2C. It is used in a bit brace as is a bit.



Fig. 2C—Countersink

In selecting screws the length is given in fractions of an inch. The diameter of the shank is given in numbers. The number five screw is about $\frac{1}{8}$ inch, the number ten about $\frac{3}{16}$ inch and the number eighteen about $\frac{5}{16}$ inch in diameter of shank.

FINISHES

For the first work in the woodshop you will have need for only the most simple finishes.

The most useful finish, because of what you learn in applying it, is *white shellac*. This is not only a durable finish, but it is so transparent that it does not destroy the natural beauty of the wood. Several coats of shellac are required to make a nice finish. After each coat the surface should be carefully sandpapered. For this use the finer grades of sandpaper.

Articles finished with white shellac can be easily repaired if injured. As the wood remains nearly its natural color much can be learned by having about the home articles of different

woods thus finished. You will become familiar with the appearance of the woods and learn to distinguish them. Any stain wastes this opportunity of learning the various woods.

Stains are usually a matter of local sentiment or changing fashion and therefore if you treat your school work to some coating which may soon go out of style, it will be apt to lose its interest.

The paint stains are the most simple stains to use. They are made by using the ordinary paint colors ground in oil. These are sold in small tin packages.

To use stains, select the colors desired, or combine two or more of the commercial colors making a shade to suit yourself. Thin the color with turpentine. Apply with a common paintbrush or cloth. Allow it to dry for a longer or shorter time according to the shade of color wanted. Then, with a clean cloth, wipe off all except that which is in the grain of the wood.

After the wiping allow the stain to dry thoroughly. It may then be brightened by going over with a cloth and ordinary floor or furniture wax. The more waxing and rubbing the better.

There is a large variety of stains on sale by dealers, which should be used according to directions furnished by the manufacturers.

Varnishing should not be attempted until you can handle a brush skilfully and can also prepare the wood in a first class manner. It is easy to put varnish on a surface so that to the novice it will appear a very fair piece of work; but such coatings are certain to result in disappointment in a short time. The wiser way for the young woodworker is to let varnish entirely alone.

DESIGN

The beginner in woodwork usually has enough to do to master the problems in tool usage which are essential to successful work.

Nearly all the designs in this course are capable of a large variety of modifications. You should first study the design as given. Not simply to fix in mind the shape of the parts, but to learn why the parts are shaped in such a manner. Go carefully over every tool operation used in making the object. This will usually throw light upon the reasons for the sizes or shapes.

After you have learned all you can by studying one design go carefully over all of the designs of a similar form, or containing similar parts.

The details, such as the shapes of edges and the sizes and spacing of the small parts, is the last step in studying the designs.

All the objects given in this course are planned to encourage such a study and if you will carefully go over them in this manner you will gain ability to work out problems in design. You should be able to work out a new and appropriate design from any lesson which you may select.

The one fact to keep in mind is that designing is not guessing, but rather taking known elements and working definitely into new forms which are within prescribed limits. In your first work in wood your design must be limited to such materials and tool processes as you are able to use successfully.

It is not possible to proceed in the same manner with all designing, but the following may help to lead you into systematic methods.

First—Select the article to be made. Second—Decide whether you wish to economize on time in doing the work or

to use any amount of time necessary to produce the best results. Third—Estimate the amount of cash outlay. Fourth—Select the material. (This will be determined not only by preferences for certain woods but also by expense and time.) Fifth—Compare the general size as compared with the type of article selected. (Consider 1 and 2.) Sixth—The chief dimension should be determined by the space which the object is to occupy or its specific use. A book rack for a few large volumes would be higher and narrower than a rack for a larger number of small books or perhaps have fewer and wider shelves. Seventh—Calculate the thickness of material for each part. Eighth—Decide upon the relative size of top and bottom. Ninth—Sketch the outline of each part. Tenth—Determine the method of joining. This is decided somewhat by the preceding steps in the process.

LESSON 1

LUMBER

This branch of schoolwork is called **woodwork**. Such wood as is used in shopwork is usually called **lumber**. You already know that lumber is made by cutting up trees. The trees are cut down by chopping and sawing and are then taken to a mill and sawed into lumber. To those who do not understand the cutting of trees and the working of them into boards or other lumber products the work appears to be very simple and to require no very definite knowledge. This, however, is not the case, for it really requires a great deal of judgment as



Fig 3—Ax

well as muscular strength. To place the logs in the mill and work them so as to get the most and best grades of lumber is a matter requiring much knowledge and judgment and a great deal of experience.

The tools used in cutting down the trees are the ax (Fig. 3) and the saw (Fig. 4). The saw which is used to fell the tree is also used to cut the tree into logs. These saws are usually about 6 feet long, have handles at each end and are called crosscut saws.

After the timber is sawed into boards or other shapes, these are taken out of the mill and piled. Sometimes the lumber is piled just as it comes from the saw mill, but usually it is sorted



Fig. 4—Crosscut Saw

into different lengths, sizes and grades and each kind placed in a pile by itself.

There are a great many different grades of pine. Other kinds of trees are not sorted into so many grades as the pine, but all are usually sorted before being worked up into building material, furniture or other products.

It is impossible for you to learn at this time all about these different kinds of lumber, but if you will examine each piece while working it, you soon will understand enough about pine and the common cabinet woods to select and purchase stock you require for your work. The piece which you have was cut from a soft pine tree. The large millsaw leaves the surface of the board very rough. This roughness may be removed by hand planing, but it is usual to run rough lumber through a machine called a surfacer (Fig. 5). Some surfacers dress but one side at a time, others dress both sides at once. Some machines, called four-sided machines, dress all four sides at once. How do you think this piece was dressed?

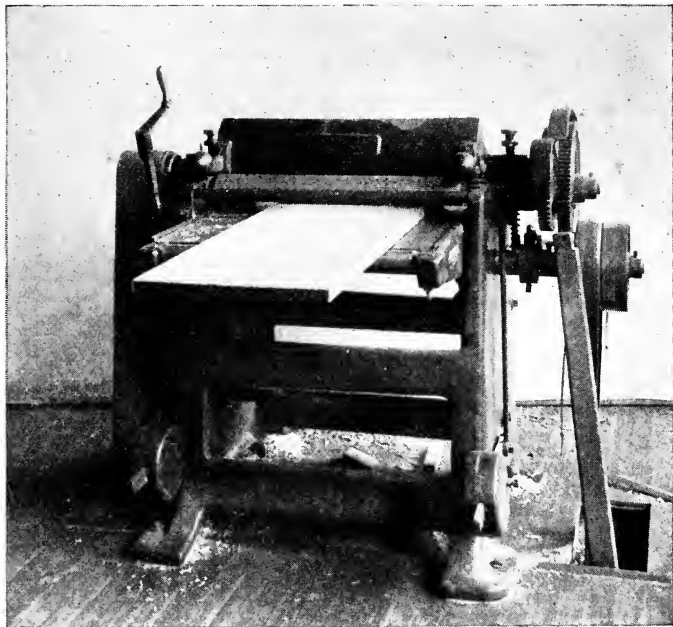


Fig. 5—Surfacing a Board

LESSON 2

INSPECTING MATERIAL

Hold the piece studied in Lesson 1 to the light and observe the little markings across the surface. Sometimes these marks are very large and uneven; sometimes they are very fine and can scarcely be seen. As they are made by the machine they are called machine marks.

Sometimes the knives which do the cutting become uneven or nicked and then a mark is made lengthwise of the piece. Fig. 6 shows two marks lengthwise and the regular fine marks crosswise. The piece photographed for the picture was much rougher than would be the case were the machine in good condition. This piece was selected because if the surface was properly smoothed the markings would not be visible in the picture.

You have nothing to do with these markings except to learn to see them, no matter how fine they are, and to remove them by using the hand plane.

No matter how smooth and straight a surface may appear when tested by using the try-square and straight-edge, if there

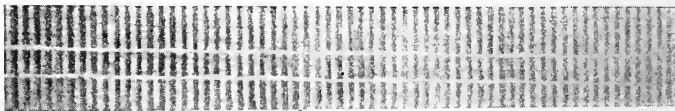


Fig. 6—Piece Showing Machine Marks

are any machine marks in it, they must be removed before it can be considered properly smoothed. After a surface is finished with varnish or any similar finish the machine marks will show much more clearly than before. Sometimes marks which are so fine as not to be noticed before applying the finish will show very plainly after varnishing. Because of these troubles, which arise from leaving machine marks in the surfaces, you must be very careful to learn in your first lessons how to see them and how to remove them. Do not be satisfied by looking at the surface in only one direction, but examine it by holding it up to the light in several positions, until you are certain that all machine marks have been removed.

LESSON 3

PLANE

The tool which is ordinarily used to remove the machine marks and true the surfaces of small pieces of lumber is the hand-plane shown in Fig. 7, called a smooth-plane. If the piece to be smoothed were larger you might use a plane like the one shown in Fig. 8, called a jack-plane. There are a great many kinds of planes, some larger and some smaller

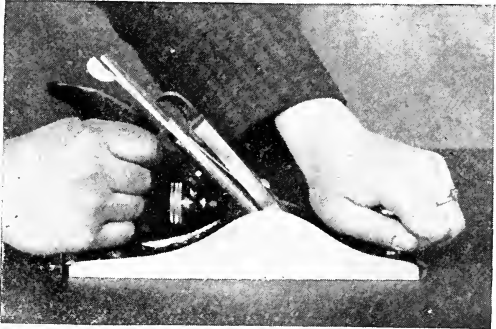


Fig. 7 Smooth Plane

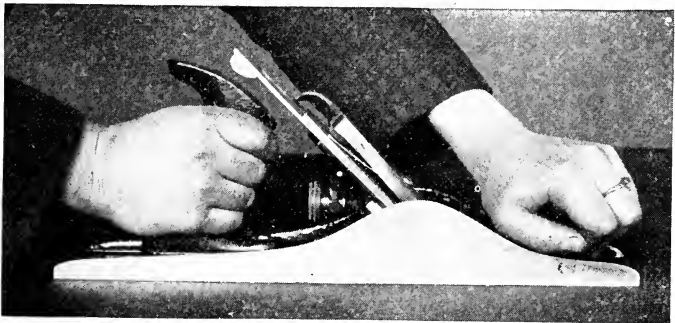


Fig. 8—Jack Plane

than these, but for the first work it is better to use only these two. After you have learned to use these properly you can study other styles. These two planes differ only in the sizes of the parts.



Fig. 9—Position for Planing

Figs. 7 and 8 show how to take hold of them and Fig. 9 shows how to place the piece against the bench-stop and the position of arms and body for ordinary planing. The parts of the plane for which you require names are given in Fig. 10.

Fig. 11 shows how to hold the plane to see if the cutting edge is properly adjusted. The lever 9 (Fig. 10)

- 1 Plane Iron.
- 2 Plane Iron Cap.
- 3 Plane Iron Screw.
- 4 Cap.
- 5 Cap Screw
- 6 Frog.
- 7 "Y" Adjustment.
- 8 Brass Adjusting Nut.
- 9 Lateral Adjustment
- 10 Frog Screw.
- 11 Handle.
- 12 Knob.
- 13 Handle "Bolt and Nut"
- 14 Knob "Bolt and Nut."
- 15 Handle Screw.
- 16 Bottom.

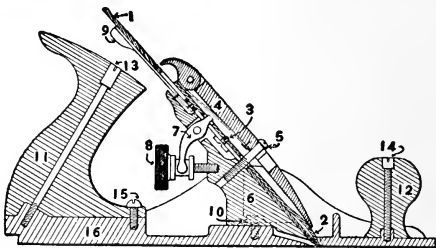


Fig. 10—Section of Plane

moves the plane-bit, so it will cut more nearly square across or more at one side or the other as desired.

The milled thumb-nut 8 is used to move the bit endwise so it will project more beyond the bottom or sole of the plane, or to withdraw it so it will project less. Your plane is probably set just right for the work you are to do, therefore do not move either the lever or the thumb-nut until the bit requires adjusting.

In order to know which way to turn the milled thumb-nut try it by turning it each way, because in some planes it is turned one way and in others in the opposite direction to move the bit downward.

As you turn the milled thumb-nut both ways to observe the effect of the turning be careful to remember how much you turn it before it begins to move the plane-bit. Do not attempt to do anything further with the plane except to put a little oil on the bottom if the bottom becomes rough because of the pine gum sticking to it. If your plane is dull or if it requires adjusting in any other manner, report it to your teacher.

Your first work in the shop is to learn how to make the sides or surfaces of pieces straight and true in all ways. You must learn this on a piece of material especially selected to



Fig. 11—Sighting the Bottom of the Plane

teach these things, for if you begin by trying to make something for use you will probably fail to learn how to plane and how to true a surface.

The methods of work given in Lessons 1 to 20 are used in working nearly every piece which you make and therefore you should be very careful to follow them exactly as they are given. Your speed in making things later in the course will depend upon the thoroughness of your study of these directions. It is a common occurrence for a pupil who is thorough in his work in making the scale and bench-hook to make a table or book-case in one-fourth of the time required by one who goes over the same lessons but does not study or understand them thoroughly.

Learn to work exactly as directed, even to the placing the fingers upon the tool, the position of the knife in drawing lines and every other detail. All these instructions are the result of much experimenting and experience with students in school shops and with practical men in actual trade work in many lines. You have the opportunity of profiting by the experience of others and if you are to get the most good from your work you must use the experience of others instead of blundering along in your own way.

Given these results you can reap the benefits at a trifling expenditure of time and effort. Your plan should be to learn the work exactly as the author gives it, and then, after a full study of his methods, you may try to work out better methods of your own, but do not waste your time experimenting or following your own notions until you know and have thoroughly tried the methods given in this book.

LESSON 4

PLANING FIRST SURFACE

Before beginning to plane look carefully at both sides and edges of the piece and select the better side for the one to be first planed. We mean by the term "side" one of the two wider surfaces. It is not usual to plane one of the narrower surfaces or edges first.



Fig. 12—Piece against Stop

Place the piece of wood against the bench-stop as shown in Figures 9 and 12 and remove one shaving, taking off the portion indicated by the light colored portion in Fig. 13. If the piece is quite straight and true the shaving may be of the same width and thickness the entire length, but probably the plane will cut from one or two high places, leaving the surface

spotted as indicated in Fig. 14. If the plane does not cut a shaving the entire length, do not go over the same place again but move the plane farther over toward the right hand side, taking a shaving as indicated in Fig. 15 and then another



Fig. 13—First Shaving Removed from a Smooth Piece



Fig. 14—First Shaving Removed from a Rough Piece



Fig. 15—Second Shaving Removed



Fig. 16—Third Shaving Removed

shaving still farther from the side first planed, as in Fig. 16. Lastly remove a shaving from the farther side of the top surface (Fig. 17) and then examine it carefully. If the piece were quite smooth the planing would appear as shown in Figs. 18,

19 and 20. Examine the surface carefully to see how smoothly the plane has cut and then turn the piece, placing the other end against the bench-stop. Plane over the surface again in the same manner as at first and then examine it. Compare the



Fig. 17—Fourth Shaving Removed



Fig. 18—Second Shaving Removed



Fig. 19—Third Shaving Removed



Fig. 20—Fourth Shaving Removed

appearance after the second time over with that of the first.

Did the piece plane easier or smoother the first time or the second time? Sometimes you will need to examine the piece very carefully in order to know which way will plane smoother.

Sometimes the piece will plane very smooth one way and very rough if planed from the opposite direction. Some pieces will not plane smooth in either direction.

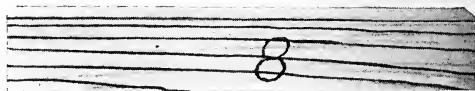


Fig. 21—Straight Grained Piece

This roughness or smoothness in planing results from the grain of the wood not being parallel with the surface. Fig. 21 is a picture of a piece in which the grain is so straight that it can be planed in either direction. Fig. 22



Fig. 22—Slanting Grain

is a picture of a piece which will plane smooth if the plane is moved from A to B, but if the end A were placed against the stop and the plane moved from B to A the surface would be made rough.



Fig. 23—Piece from Near a Knot

The piece shown in Fig. 23 will not plane smooth in either direction, for the grain at A is in one direction and that at B in another. As it is impossible to plane such a piece smooth the entire length you should plane it the way which will make it the smoothest. In this case this will be accomplished by planing from C to A.

By carefully studying the grain of each piece which you work you can judge the way of the grain before you plane. This will save both time and material.

By carefully studying the grain of each piece which you work you can judge the way of the grain before you plane. This will save both time and material.

Fig. 24 shows one of many causes of crooked grain in wood. The piece shown in Fig. 23 was cut from this board above the large knot. This knot is the cause of the crooked grain. You can easily imagine how the grain will bend around a knot and how the effect extends several inches from the knot.

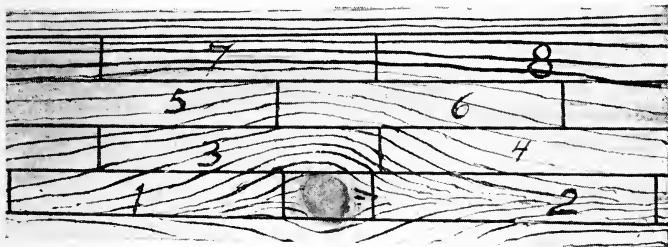


Fig. 24—Board with Knot

There are many peculiar freaks in the grains of different woods which you will learn as you work pieces of various sizes and shapes. Now that you understand how to examine the grain and how to place the piece to make the smoothest surface, you can continue planing over the surface systematically until it is smooth entirely across. Follow the plan indicated by the illustrations (Figs. 13 to 20).

After learning which way will plane the smoothest, plane the piece only in that direction, no matter which end requires the most planing.

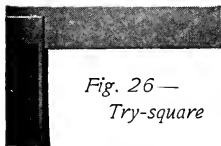
LESSON 5

TESTING THE FIRST SURFACE

You have now planed the surface until it appears to be smooth, and must test it more carefully by using a try-square.



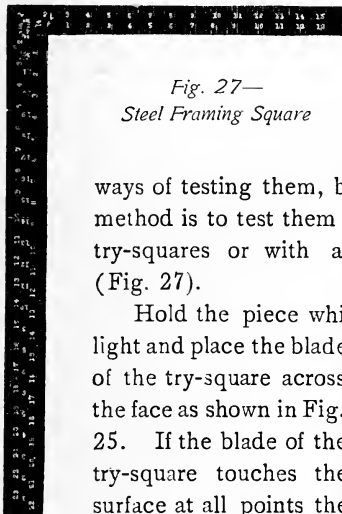
Fig. 25—Testing from Edge to Edge



*Fig. 26—
Try-square*

Fig. 26 shows a try-square such as is used in many schools. The try-square consists of two parts. The thicker part is called the head or beam, and the thinner part is called the blade. Try-squares are made in many styles and sizes, but all the forms

suitable for use in beginning the study of woodwork are similar to the one shown.



*Fig. 27—
Steel Framing Square*

The ordinary try-squares for use of carpenters, cabinet makers and similar tradesmen are not expensive tools and sometimes such try-squares are incorrect. There are many ways of testing them, but for the beginner the best method is to test them by comparing them with other try-squares or with a large steel framing square (Fig. 27).

Hold the piece which you are planing up to the light and place the blade of the try-square across the face as shown in Fig. 25. If the blade of the try-square touches the surface at all points the surface is correct as tested from edge to edge.

If the try-square does not touch all the surface the piece is incorrect and instead of planing over the entire surface in a systematic manner as at first directed you should now move the plane so it will cut off the high places only.



Fig. 28—End View of Plane

You have probably discovered that the plane cuts deeper

near the center of the cutting edge, therefore the center of the cutting edge should be moved over the high places as shown in Fig. 28. In this case the plane is moved so it will cut a shaving near one edge. Continue planing in this manner until the surface is true as tested by applying the try-square from edge to edge.

After the surface is true from edge to edge, hold the piece to the light and sight from end to end as shown in Fig. 29.



Fig. 29 — Sighting Lengthwise.

This is to see if the piece is straight. Be sure to hold the piece in the proper position to get a ray of light. Usually to do this the piece must be held up from the bench. After you have examined the piece in this way, set the plane on the surface as shown in Fig. 30, tipping it just enough to allow light

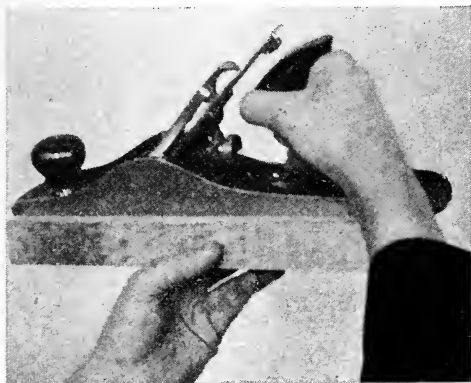


Fig. 30—Using the Sole of the Plane as a Straight-edge

to pass under it.

A straight-edge may be used in a similar manner.

In grasping the straight-edge hold it near the center as shown in Fig.

31 whether it be wider at the center or straight on

both edges. The machinist steel

straight-edges which may be used for this purpose

have parallel edges. If there is any space between the piece and straight-edge at either end of the piece or at any other point along the length, plane down the high places until the piece is straight. In doing this planing be careful to keep the piece correct as tested from edge to edge in the first test.

Probably your chief difficulty is that you do not press down enough on the toe of the plane in starting the stroke, and not enough on the heel of the plane in finishing the stroke. If the piece is low at the ends and you bear down on the plane

properly it will not begin to cut until after the cutting edge has passed beyond the low place, and it will cease to cut as it nears the opposite end. See Figs. 32 and 33.



Fig. 31—Using a Wooden Straight-edge

Sometimes it is necessary to remove the shavings from but a part of the length. In such a case do not place the plane down on the surface and then begin to move it forward or stop the forward movement and lift the plane abruptly, but keep the plane moving forward as it is lowered to the surface and gradually raise it before it ceases to move forward in finishing the stroke. If this is done, there will be no marking of the surface where the shaving cut begins or ends.

In all of this planing be careful to move the plane so slowly that you can see just exactly how it is cutting at every part of

the stroke by looking down into the space where the shaving comes up. This space is called the mouth of the plane. If

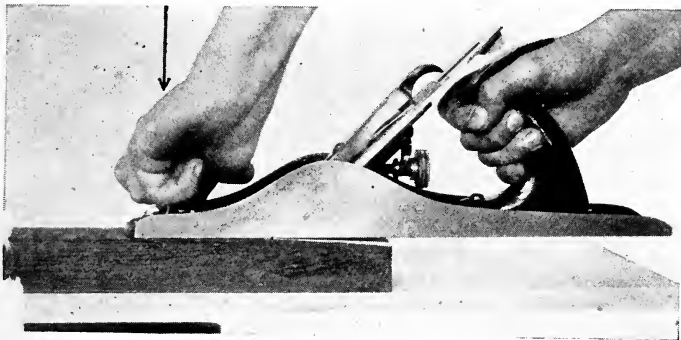


Fig. 32—Starting Plane

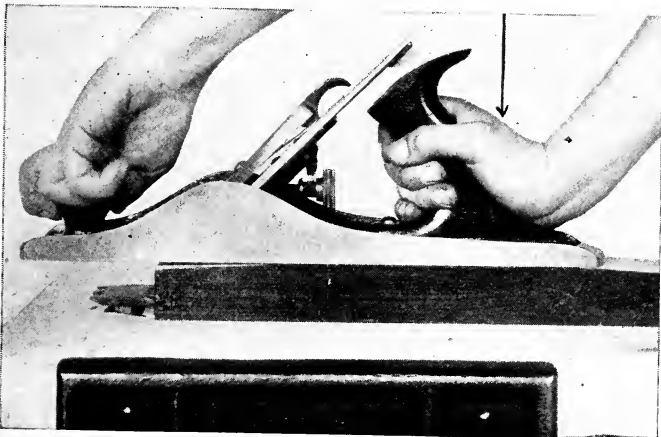


Fig. 33—Finishing Stroke

you are obliged to move quickly in order to make the plane cut, either sharpen the plane or change the set so that it will plane easily enough to allow of very slow movement. Sometimes it is necessary to grind the planes very rounding (Fig. 108), so that they will take a very narrow shaving and require less strength to do the work. Sometimes a little oil on the plane bottom will cause the plane to work easier.

LESSON 6

SIGHTING FOR WIND

You now have a surface true in two ways, but this is not enough. In order to be true enough for use in good work, it must be correct when tested in three ways. The first test from edge to edge, and the second test, sighting for straightness from end to end, may indicate that the piece is all right, and yet if you lay the piece upon a flat surface and press down upon one corner, and then upon another, the piece may rock, or one corner be lifted as another is pressed down. When the piece is not true as tested in this manner it is said to be "in wind." This word is pronounced with *long i* and means much

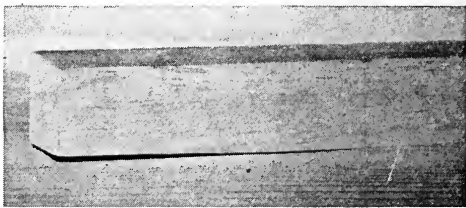


Fig. 34—Piece on Flat Surface Showing Wind

the same as the word twist. Fig. 34 shows how such a piece would rest upon a flat surface and Fig. 35 shows how such a

piece would appear if looked at from one side. These pieces are much more in wind than you are likely to get for your first test piece, and because of this the crookedness is quite visible in the picture.

If the piece is in wind even a very little, it must be made straight before it can be used, and therefore you must study



Fig. 35—View of Surface of Winding Piece

carefully to know what is meant by the word wind and must also be certain that you can readily see whether the piece is in wind or not. If the piece is correct we say it is out of wind, or not in wind.

The most convenient and practical way to examine a piece for wind is to hold it up in both hands between your eyes and the side light as shown in Fig. 36.

First roll the piece until you cannot see any of the back edge, the edge farthest from you, and then roll the piece very slowly in the opposite direction until you can just see the back edge. If the piece is true, or not in wind, you will see all of the back edge alike, but if the piece is in wind, one back corner will show more than the other back corner. The corner which is more visible is called the high back corner, and must be planed down until both back corners appear alike.

Before doing any planing upon the high back corner, mark an X upon it and then turn the piece so that the X will be at the edge near your eye. Examine the piece again as at first and you will find another high back corner.



Fig. 36—Sighting for Wind

Mark this high corner also and if you have examined the surface properly, you will have the two X's on the two diagonally opposite corners. This second test is to teach you that if there is a high back corner, there is also a high front corner at the opposite end, therefore in planing to make the surface true, you can plane off either high corner, but usually you should plane a part off each of the high corners.

Before you plane either corner, examine each end to see if one end is thicker than the opposite end. If there is any difference in the thickness of the two ends, you had better plane off the high corner at the thicker end so that you will be making the piece nearer equal thickness at the two ends at the same time you are planing down the high corners and getting the piece out of wind.

In planing out of wind, work very carefully and test the piece very often. If you have any trouble about making the surface true, test it in these three ways after each shaving is removed. Unless you make these tests you will waste much time by making the piece incorrect in other ways as you attempt to plane it out of wind. Be careful to keep the piece smooth as well as true, but if you cannot avoid making marks where you start or stop the plane, go all over the surface systematically, as directed in Lesson 4, after the surface has been planed true.

Do not give up until the surface is correct as tested in these three ways, for you can make it correct if you will work carefully according to the directions. The common mistake is to neglect testing it often enough.

LESSON 7

FACE-MARK

After the surface has been made true it should be marked so that you know it has been tested and found correct, and also so that you know which is the surface you first trued. The mark which is used for this purpose is called a *face-mark*, and the surface is called a *face-surface*. The face-mark is of

much importance, and you must be very particular to place a mark of this character on the first surface of every piece which you work as soon as the surface is correct.

The mark should be similar to the one shown in Fig. 37, but it need not be exactly like it. Usually it is located near



Fig. 37—First Face-mark

the center of the piece and is made free hand. It always extends entirely to one edge and never to both edges. The reason for this is that the edge to which it extends is the one to be planed next, the one which will receive a similar mark, and which is called a face-edge.

For this reason you must examine the piece and determine which edge is to be the face-edge before making the mark on the first surface. If the piece is to be cut up into two or more pieces, face-marks should be placed on the surface so that after the parts are separated there will be a face-mark on each piece.

LESSON 8

KEEPING THE PLANE SHARP

In all planing you must keep the plane sharp. You not only can learn to sharpen the plane, but you can learn also to do something which will avoid dulling it rapidly.

If you have a board which has not been machine planed or surfaced, brush all grit and dirt off the surface before beginning to plane it. By being careful to plane systematically, you will true the surface with much less planing, and thus not only do better work, but also will use the plane so much less that it will remain sharp much longer.

If, in using the plane, as it is drawn back the cutting



Fig. 38—Lifting Plane on Return Stroke

edge rubs upon the surface of the piece being planed, the edge will be dulled more than while cutting on the forward stroke. Because of this you should either lift, tilt or swing the plane as you pull it back.

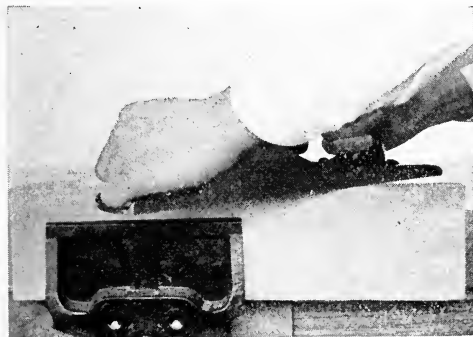


Fig. 39—Swinging Plane on Return Stroke

Fig. 38 shows how the plane is lifted so that on the return stroke it rests upon the toe

of the plane instead of on the cutting edge of the bit. For most work this is the best way to hold it on the return stroke.

Sometimes the piece is too narrow to permit of lifting it in this manner. It may then be turned to an angle as shown in Fig. 39. This is the usual way of holding it in jointing edges.

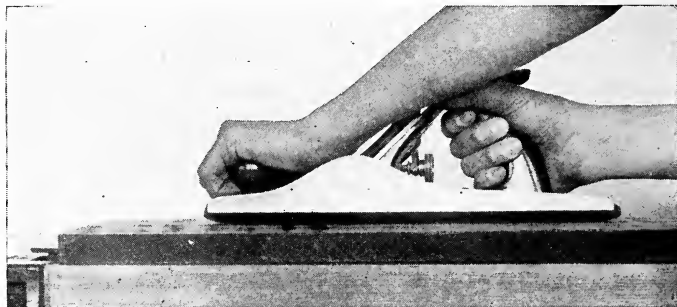


Fig. 40—Tilting Plane on Return Stroke

The one difficulty about turning the plane in this manner is that you may neglect to turn it entirely back to a position parallel with the edges for the forward stroke. Be sure to guard against this, for if you do not it will take much longer to make the surface correct.

A third method, which is more often used in planing wide surfaces, is to tilt the plane as shown in Fig. 40. Carefully study each of these methods and use whichever is best for the work in hand.

LESSON 9

FIRST EDGE

The next task is to plane an edge for a face-edge. This edge must be true as shown by testing with the try-square as

in Fig. 41 and also by sighting for straightness, as shown in Fig. 29. After you have sighted the edge, you may use a straight-edge, as in Fig. 31, or the plane bottom as in Fig. 30, but do not use either of these until you have examined the edge by sighting it. There are two reasons why you should not depend upon the straight-edge or the plane bottom: First, if you do not use your eye you miss the opportunity of learning the best methods and learning to work rapidly; second, you will soon be working on pieces too long to test with the plane or straight-edge, and if you have not learned to sight with your eye, you will be unable to do good work.

In using the try-square hold it as shown in Fig. 41, pressing the head firmly against the face-surface. Be partic-



Fig. 41—Testing First Edge

ular to hold the wrist and forearm as shown in Fig. 42, for much of your success will depend upon the position of your arm and wrist. Do not rub the blade along the edge, but lift it and



Fig. 42—Testing First Edge

lower it at several places. Be sure to test to the ends.

The planing of the edges follows substantially the same methods as the planing of the surface, as illustrated in Lesson 4.

The edge being narrow you will need to be careful not to move the plane too far out over the edge. This is also an excellent opportunity to carefully keep the plane parallel with the edges of the piece

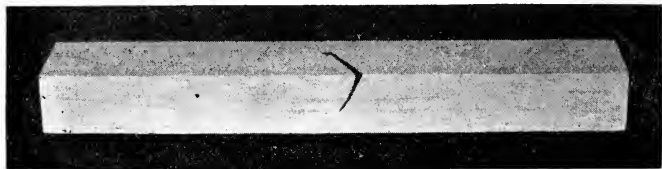


Fig. 43—Face Mark on Edge

as shown in Fig. 12. It is improper to swing the heel of the plane at an angle on the forward stroke in doing such work. It not only wears the plane out of true, but hinders you from doing the best work.

After this edge is correct, place a face-mark on it pointing to the one on the face-surface as shown in Fig. 43. It is not essential that the ends of the two marks meet at the corner.

LESSON 10

MARKING GAUGE

The marking gauge (Fig. 44) is a tool for use in drawing lines parallel with an edge. It consists of two principal parts, the block, or head, and the beam, or bar. To keep the parts in place there is a thumb screw or some similar arrangement in the head.

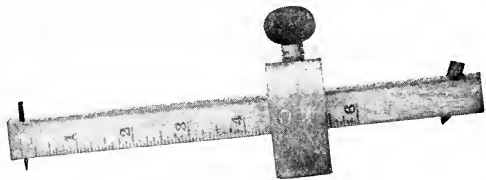


Fig. 44—Marking Gauge

The line is made by the small metal point called the spur or by a pencil shown in the opposite end. The shape of the spur is shown in Fig. 45. The manufacturers usually fit the spur with a conical point. Before the gauge is used the point should be filed to the proper form.

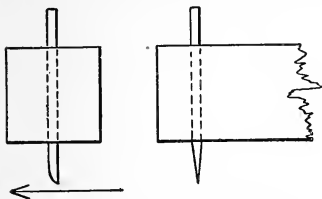


Fig. 45—Point of Gauge Spur

The manufacturers usually fit the spur with a conical point. Before the gauge is used the point should be filed to the proper form.

The marking gauge is not usually supplied with a pencil point by the maker, and therefore if you wish it to make a pencil line you will bore a hole through the beam and fit a pencil into it. The pencil point should be short. (Fig. 44.)

You will probably find some graduations on the side of the gauge beam similar to those on your rule, but do not use them for they are not usually correct. If they are correct, the spur

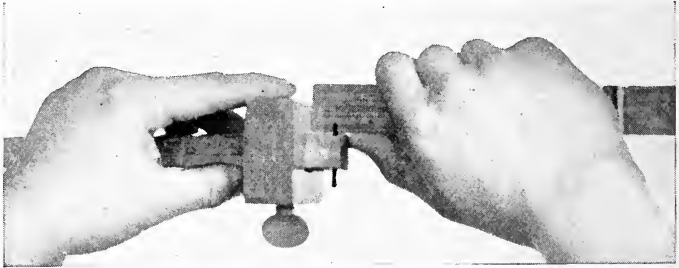


Fig. 46—Setting Gauge

may not be at exactly the end of the scale and, therefore, if you set the head by the scale the space which would be

marked by the spur would not be correct.



Fig. 47—Pocket Rule

Because it is not safe to use the scale on the side of the gauge beam you should set

the gauge by holding it and the rule as shown in Fig. 46.

Notice that the rule is held in the right hand so that the four fingers are around the rule and the thumb underneath, with the end against the gauge-beam. Notice also that three fingers of the left hand are around the gauge-beam, the first finger on top of the gauge head and the thumb against the side of the gauge head directly below the beam. Be sure to place your hands and fingers in exactly this

manner; it will enable you to set the gauge quickly and exactly.

As lines are made to work to, it is important that you make the lines correctly. It is often discovered that the main difficulty a beginner has is caused by carelessness in making the lines. Because of a belief that the lines are of little consequence they are carelessly drawn and much time is afterwards spent in trying to make the parts fit. If the lines had been correct, the work could have been better done with half the labor. Be very careful in setting the gauge and drawing the lines and in making any other lines which you require in your work.

If you will examine your rule, which should be a No. 84 or a No. 62, you will find the rulings which are on the outside edges, as the rule is folded to six inches, are inches, half inches, quarter inches and eighth inches. (See Fig. 47.) At present, pay no attention to any of the rulings except these. In the No. 84 rule these marks are along the brass binding. Notice that the one-half inch marks extend about half way across each side, that the one-fourth inch marks extend to or past the line farthest from the edge and that the one-eighth inch marks are the shortest ones on the scale, extending about to the first line. Be sure to fix in mind these features of the rule, as all rules for practical measuring are made after this general plan. If you become familiar with these markings you will readily learn to use any ordinary scale.

Your next bit of work is to draw lines on the face-surface or face-side of the piece you have planed. After all the lines have been drawn, the surface will appear as shown in Fig. 48. In this figure the outer lines represent the edges of the face-

surface of the piece. The four inside lines represent the lines to be drawn. The short vertical lines which terminate in arrow

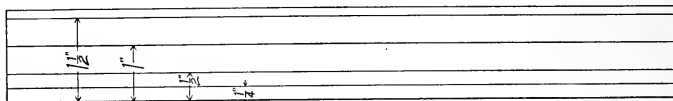


Fig. 48—First Surface Lined

heads are called dimension lines. Notice that each line has one arrow head at the lower or border line of the figure and one arrow head at an inner line. This designates that the figures on the dimension line tell the distance from the edge to that line.

The $\frac{1}{4}$ inch space is so small that there is not room for figures and arrow heads between the two lines. The arrow heads are therefore

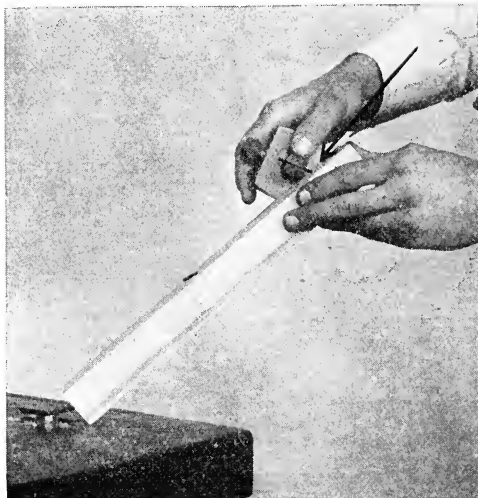


Fig. 49—Drawing Gauge Line

placed outside of the lines, with points just touching them to indicate which lines are intended. The figures are placed

between the two lines, in line with the two arrow heads. Study this drawing until you are certain how the gauge lines are to be drawn. The line $\frac{1}{2}$ inch from the face-edge is the easiest to draw, and therefore you may set the gauge to $\frac{1}{2}$ inch, holding it and the rule as shown in Fig. 46.

Take the gauge in your right hand holding the piece against



Fig. 50—Drawing Gauge Line

the bench-stop as shown in Figs. 49 and 50. Notice that the right arm is parallel with the piece you are gauging. This is still more easily seen in Fig. 52.

The gauge must be held so that its beam rests upon its edge instead of resting upon the spur, for if it rests upon the spur it will be impossible for you to draw an even line in wood which has uneven

grain. Fig. 51 shows how the beam is rolled to cause it to rest upon its edge; it also shows how the spur slants instead of being perpendicular to the surface. To learn to use the gauge, take the position shown and move the gauge from the upper to the lower end of the piece, but with the beam rolled so that the spur will not touch the wood. After making this

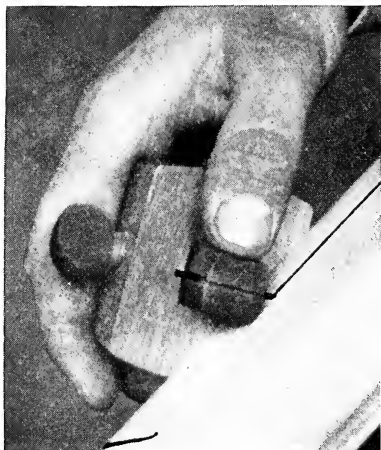


Fig. 51—Rolled Gauge

very important, for if the head is not tight against the face-edge, the line will not be correct.

Gradually roll the beam until the spur enters the wood enough to make a line of the proper weight. As the gauge nears the lower end of the piece it may

movement several times, roll the beam so that the spur will just touch the surface, but not enough to make a full line. In the use of the gauge watch the position of the beam and head by looking under the beam and next the head so that you can see if the head is firmly against the face-edge, as indicated by the arrow in Fig. 49. The holding of the head against the face-edge is



Fig. 52—Rolling Piece at End of Line

be necessary to roll the piece as shown in Fig. 52, in order to avoid hitting the bench with the head of the gauge. Fig. 53 shows this rolling from the opposite side. Notice that the right arm is parallel with the piece.

After you have drawn the $\frac{1}{2}$ -inch-line set the gauge to $\frac{1}{4}$ inch and draw a line $\frac{1}{4}$ inch from the face-edge. Next draw a line 1 inch from the face-edge, and then a line $1\frac{1}{2}$ inches from the face-edge.

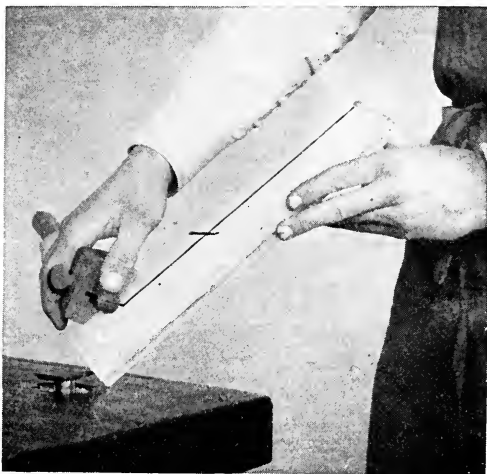


Fig. 53—Rolling Piece at End of Line

LESSON 11

PLANING TO WIDTH

Place the piece on which you have drawn gauge lines on top of the bench against the stop. Do not drive it against the stop. Plane the second edge down to the gauge line, making the piece $1\frac{1}{2}$ inches wide. Test this piece by using the try-square as shown in Fig. 42. If you plane exactly to the line, and the line is correct, the one test with the try-square is

sufficient, but as you are likely to plane beyond the line, or perhaps the line may not be correct, you had better test it in several ways. You may examine it by sighting for straightness, as in Fig. 29. Another test of considerable importance is to measure the width at several places by applying the rule as shown in Fig. 54.

In using the rule to measure with, it should be held so that the graduations are against the surface which is being measured. It is best to place the end of the thumb against the edge of the piece to assist in adjusting the markings of the rule to the exact position desired.

In using the rule, use the markings away from the end, if this can be done. In Fig. 54 the scale is placed so that an inch line

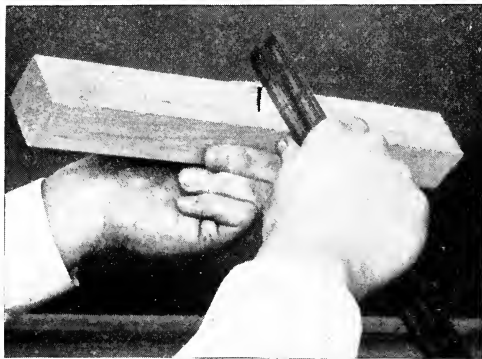


Fig. 54—Measuring Width with Rule

is at the edge by the face-mark. It is not incorrect to hold it so that the inch line is at the opposite edge. Always hold the rule in this manner for measuring and you will soon do as accurate measuring as

the average mechanic. You will probably find that the piece is a little less than $1\frac{1}{2}$ inches. If in setting the gauge you set the point of the spur exactly behind the $1\frac{1}{2}$ inch line, and then planed

the line entirely away, the piece is one-half the width of the line too narrow. This is because the spur bruises the wood at each side of the point and makes a line of some width. For this reason, in setting the gauge for planing to width or thickness, it should be set so that the inside of the line will give the correct space. In all other gauging, set the spur exactly to the line on the scale.

If by measuring the width of the piece, you discover that it is wider at one end than at the other, set the gauge to the narrow end and draw another line. Plane to this line the same as in planing to the $1\frac{1}{2}$ inch line. Remember to test the edge with the try-square as well as by measuring. When this edge is correct, pass to the next surface or second side without putting any mark upon this edge. The two face-marks, the one on the first surface, (Fig. 37) and the one on the first edge, (Fig. 43) are the only ones used to denote face-surfaces, or that the surfaces are finished.

LESSON 12

PLANING TO THICKNESS

The gauge should now be set to $1\frac{1}{4}$ inches, (See Drawing Fig. 66) and lines should be drawn along each edge $1\frac{1}{4}$ inches from the face-side. Lines should also be drawn across each end. If in drawing these lines you stand at the end of the bench near the bench-stop, you can place the piece against the stop in drawing the long lines and lay it down at the corner of the bench, as shown in Fig. 55, while drawing the lines across the ends.

Remember what was said in the previous lesson about setting the spur so that the piece will be full size after the entire

line has been planed away. If in planing the first surface you planed away so much of the material that the piece is less than $1\frac{1}{4}$ inches thick, you may set the gauge to the thinner end and draw a line entirely around the piece and then plane down to this line.

The fourth surface or second side may be tested by meas-



Fig. 55—Lining Across End

uring as in Fig. 54, and also by sighting for straightness, but if you are careful to plane exactly to the lines, the only test required is the testing from line to line as on the first surface, shown in Fig. 25.

When you think the piece is finished, take the try-square and rule and test it in every way that you can, to see if you have overlooked any in-

accuracies. If you find any errors, go carefully over the work and correct them. Follow the same order and the same directions as in working the surfaces the first time. If necessary, go back to the first surface and true it, then repeat every test.

LESSON 13

LAYING OFF SPACES—DRAWING OF SCALE

Lay on the bench the piece which you have finished planing and hold the rule on edge on the piece as shown in Fig. 56. Notice that the rule is placed on the piece so that there is about $\frac{1}{4}$ inch of wood projecting beyond each end of the rule. Do not attempt to measure this amount of projection, but place the rule in position, leaving an equal amount of projection at each end as nearly as you can judge with-

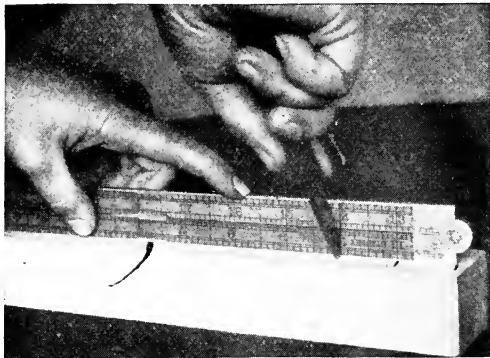


Fig. 56—Rule in Place for Marking Spaces

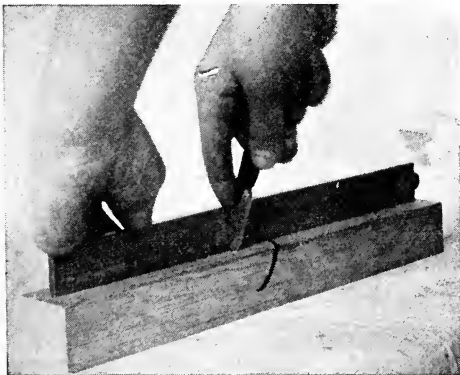


Fig. 57—Detail of Knife in Hand

out measuring. These projecting ends are to be cut off as the piece is finished, and therefore their exact length is of no consequence. Take your knife in your right hand and make a mark opposite each inch graduation and at

each end of the rule. Fig. 57 shows the knife and rule from the left side. These marks should be made with great care and should extend square out from the rule. In order to do this work accurately, you must be very particular about how

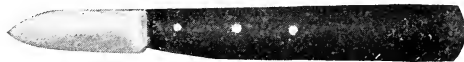


Fig. 58 - Bench Knife

you hold your knife. Do not hold your knife so that the handle extends

upward between the thumb and forefinger, but rather in the hand and underneath the first finger as shown in the picture.

The knife should have a sharp point similar to those



Fig. 59 - Pocket Knife

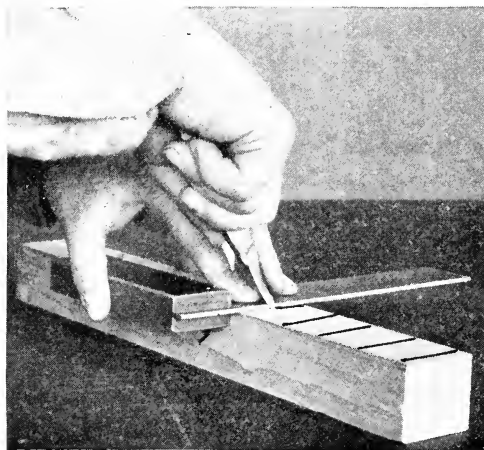


Fig. 60 - Knife and Try-square

shown in Figs. 58 and 59. The handle should not be too large or too small. The bench-knife, Fig. 58, is not equal to a good pocket knife, but will do very well.

It should be kept with as sharp a point as the width of the blade will per-

mit. The ordinary difficulty with such knives is that the blades are too long. They should not be more than $1\frac{3}{4}$ inches long. Sometimes for smallhands the handle also should be shortened.

The pocket knife, Fig. 59, has a handle three inches long, and is about $6\frac{1}{4}$ inches long from tip to tip of the blades. The little blade should be used for all lining. The large blade

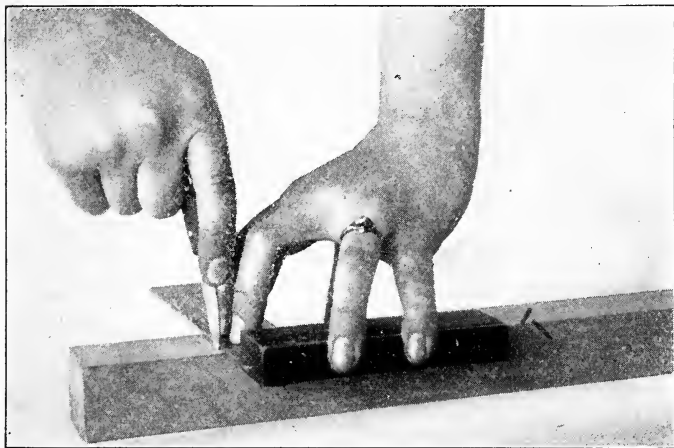


Fig. 61—Knife and Try-square

is sufficient for whittling round ends such as are used in racks, chairs, etc.

After a mark has been made at each 1-inch line, lay the rule aside and place the try-square on the piece; the head against the face-edge, two fingers on the blade, two against the piece, and the thumb against the middle of the head of the try-square as shown in Fig. 60. Place the point of the knife

blade in one of the marks made in laying off the spaces and move the try-square up to the knife blade. Be careful to hold the knife blade as shown in Figs. 56 and 57.

After the try-square is in position, draw a line entirely across the piece. Be sure the knife is held in the same position during the entire process of lining. Continue to draw lines in this manner at each mark until the head of the try-square extends to the end of the piece. Reverse the piece and the try-square, holding them as shown in Fig. 61, and finish drawing the lines.

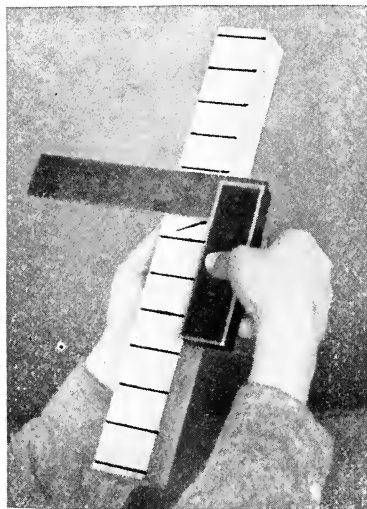


Fig. 62—Testing Lines on Scale

After all the lines are drawn at the inch spaces, take the piece and try-square as shown in Fig. 62 and examine each line. If any are found to be incorrect, draw again at that point, being careful to set the blade by the original knife mark and not to a crooked part of the line. Keep trying until you have a straight line at every inch even if it does injure the appearance of the piece, for it is of much more consequence that you learn to draw the lines than that your piece has no extra lines.

The next step is to lay off the $\frac{1}{2}$ inch spaces and draw

lines from the line which is one inch from the face-edge to the face-edge. Hold the try-square and knife in the same manner as in drawing the lines at the 1 inch divisions, reversing when required to keep the head of the try-square on the face-edge. Test these lines in the same way as directed for testing the 1 inch lines. (Fig. 62.)



Fig. 63—Scale

Lay off the $\frac{1}{4}$ inch spaces and draw lines from the line which is one-half inch from the face-edge to the face-edge. Draw and test these lines the same as the 1 inch lines.

Lay off and draw the lines at the $\frac{1}{8}$ inch spaces. You will need to be very particular about these lines or the spaces will not be equal. Lay the rule on edge on the piece and examine all the spacing carefully. If it is all correct, the scale is complete and will appear as in Fig. 63, and if not, you had better make another scale on the opposite side.

Draw gauge lines on the back-side the same as you did on the face-side, being careful to hold the head of the gauge against the face-edge.

In order to locate the scale on the opposite side, draw a line across one edge, place the point of the knife blade in the end of the first inch line and move the try-square up to the

knife blade the same as in drawing the line for the scale. (See Fig. 64.) Next place the knife point in the end of this line and draw a line across the back side. If the face-edge is next to you, the knife may be held as shown in Fig. 65 in setting the try-square. The line is then drawn in the usual manner. (Fig. 64.)

In lining around a piece it is better to set the try-square

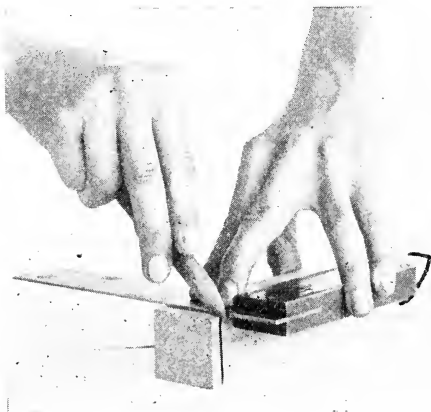


Fig. 64—Setting Try-square at Corner

by the line on the face-edge, even though the one on the back-edge has been drawn.

If you have a scale on both sides of your piece, set the marking gauge to enough less than the thickness of the piece to allow for planing the scale off and draw lines along each edge. Exam-

ine the scales and plan to plane off the poorer one.

After the lines have been drawn, plane off the scale and test the piece as you tested the fourth side, Lesson 12. Be very careful to plane exactly to the lines or you will have trouble getting the piece in proper shape. Set the marking gauge to $\frac{3}{16}$ inch and draw lines on each edge with the head of the gauge against the side which has no scale upon it.

Extend all the lines which mark the half inches on the scale entirely across the surface. Extend these lines down on each edge to the lines which are $\frac{3}{16}$ inch from the other side. Be very careful to have the lines meet exactly at the corners. Place the knife as shown in Fig. 64 and draw the line as you were directed to draw the line across the edge, except that you should now stop at the line which is $\frac{3}{16}$ inch from the edge. The piece will then appear as in Fig. 66.



Fig. 65—Setting Try-square at Corner

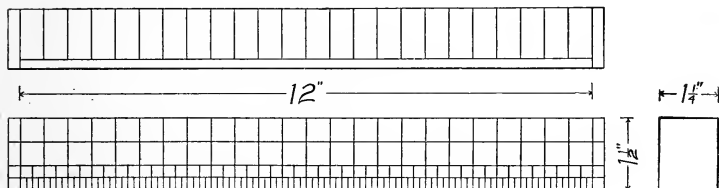


Fig. 66—Piece Lined for Sawing

LESSON 14

SAWING

The back-saw (Fig. 67) has so thin a blade that a piece of metal is placed along the back to keep the blade from bending.

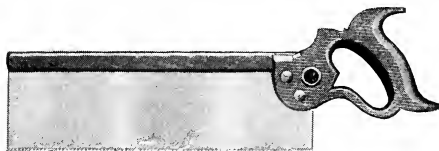


Fig. 67—Back-saw

Back-saws are used for cutting across the grain. Tenon saws may be similar to back saws except that they are filed so that they

can be used for cutting either across the grain or parallel with the grain. These are now seldom used, as saws are so cheap that it is much better to have two saws, one to saw across the grain and one to saw parallel with the grain. Place the bench-hook on the bench and the piece lined in Lesson 13 upon it and grasp the back-saw as shown in Fig. 68.

Notice that the thumb is against the saw and upon the wood close to the back edge of the piece. Notice that the first finger (Fig. 69) extends along the side of the handle. Place your thumb so that the saw will cut up close to one of the knife lines which extend entirely across the surface. Be sure that the saw leaves the smooth edge made by



Fig. 68—Holding Back-saw

the knife. . Move the saw forward and backward the length of the blade, the lower edge of the side of the blade resting against your thumb and the teeth of the saw close to the wood but not cutting it. (Fig. 68.) Move the saw forward and backward in this manner without doing any sawing until you understand the motion thoroughly.

Look at the angle formed by the side of the saw with the surface of the piece. This should be an exact right angle and if you are careful you can hold the saw so it will be. To assist your eye, at first, you can set a try-square as shown in Fig. 70. You will observe that if the movement of the saw is cor-

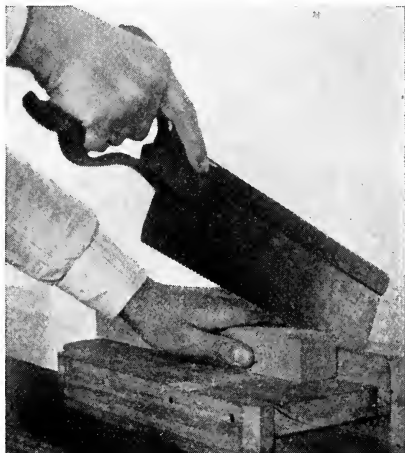


Fig. 69 - Detail of Sawing

rect, the wrist is rigid and the elbow the moving joint. You will also be supporting the saw with your hand.

When you have studied this movement until you understand exactly how the motion is made, you can lower the saw just enough to allow the teeth to touch the wood at the back edge, but not enough to cut, still keeping the wrist rigid, and holding the saw at the same angle as shown in Fig. 68.

Move the saw forward and backward several times in this manner, lifting it entirely from the wood on the back stroke.

Then let it cut a very little on the forward stroke, still lifting it on the back stroke. After the kerf (the channel which the

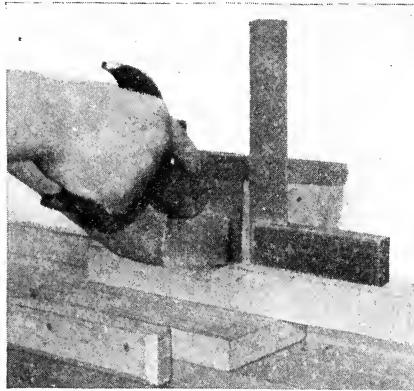


Fig. 70 - Try-square at Side of Saw

forward stroke lower the handle a little until the saw has the position shown in Fig. 71. After sawing a little more the saw should have the position shown in Fig. 72. Watch



Fig. 71 - Sawing, Third Position

kerf (the channel which the saw makes) is well started you will not need to lift the saw on the back stroke and can lower the handle a very little. The thumb may now be moved to the position shown in Fig. 69.

As you lower the handle, watch the knife line to see that the saw is cutting close to it but not roughing the edge of the wood. At each

constantly for the right angle at the side of the saw and as soon as the kerf extends across the surface watch the line at the front edge to see that the saw is cutting close to it but not roughing it. Stop after each few strokes and examine the back edge. See that the saw is cutting close to the back line but not roughing it. On the side of the saw-kerf opposite the line at the back side of the piece, the edge will be roughened because there is no knife line on that side. If you wish to have the wood at both sides of the saw smooth, you must draw two lines just far

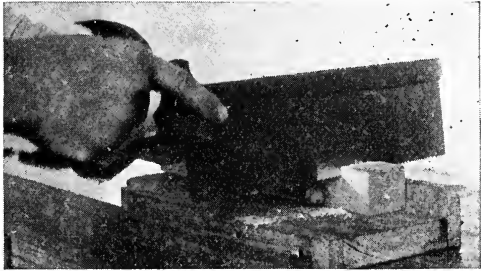


Fig. 72—Sawing, Fourth Position

enough apart to allow of sawing between them. Continue sawing until the kerf extends to the lines which are $\frac{3}{16}$ inch from the bottom side of the piece. Be careful to saw exactly to these lines and no farther, for the piece is to be bent and if the saw cuts too far the piece will break instead of bend. Fig. 73 shows the piece after it has been bent. Saw at the same side of each line which extends across the piece. Turn the piece end for end as soon as it will make the holding easier.



Fig. 73—Piece Bent

OUTLINE

After completing the study piece make an outline showing each step in making this piece. This will be found of great value, for, in working the pieces for the bench-hook you will need to recall the order in which the sides and edges are worked, the tests for each surface, each operation in laying off spaces, drawing lines, and sawing.

LESSON 15

BENCH-HOOK

You have learned to plane all four sides of a piece so that the surfaces will be true and so that their ends will be of the same size and shape. You can now use this knowledge in making simple things.

The bench-hook requires but little knowledge beyond that required for making the scale, except for the end planing. Be

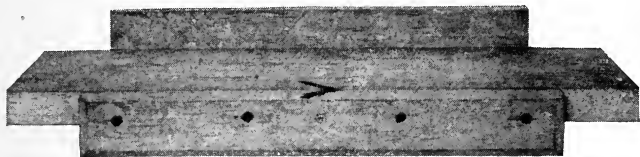


Fig. 74—Bench-hook

very particular to true each surface exactly as directed in making the scale, using the same tools and in the same order. Because these pieces are fastened together, any carelessness in jointing the edges or truing the surfaces will be discovered and may show badly. Try to forget all about the fact that you are making a bench-hook and try to feel that you are simply studying. This will help you to keep your mind on the work, for it is much more interesting to see how well you can do than to simply make something to use. If you do your best you will be rewarded many times, for you will be rewarded every time a surface or end is finished.

Fig. 74 shows the completed bench-hook. It consists of three pieces of wood and eight nails. Fig. 75 is a mechanical

WOODWORK FOR THE GRADES

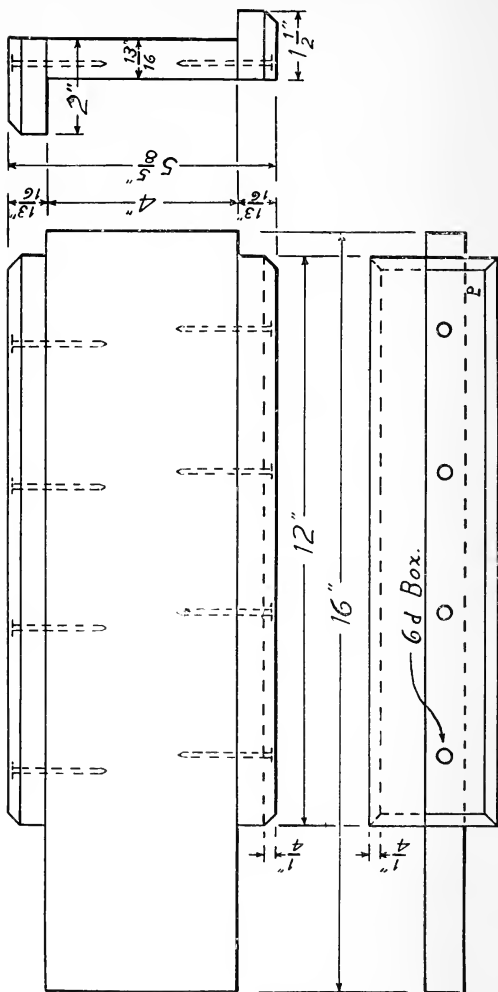


Fig. 75—Bench-hook

drawing of the complete bench-hook. In this drawing, each piece is shown, and also the nails. Usually, in such drawings the nails are not shown. They are shown in this one so that you will be able to drive them correctly. You will notice that they are represented by dotted lines. This is because they are out of sight. The heads are full lines or circles, in the front elevation, because, as we look at the edge of the bench-hook, we see the nail heads.

If you will look at this same view where the nail heads show (the front elevation we call it) you will see a dotted line almost the entire length of the elevation. At each end, the line is full, because the ends of the wide piece show beyond the side pieces. From these ends you can trace the line and learn that this dotted line is to indicate that the wide piece is the same thickness from end to end. By using dotted lines, we indicate edges that are not visible.

The plan shows the wide piece and the dotted lines for the nails and the edges of the side pieces. This view, or plan, as it is called, shows in full lines what you would see if you were to place the bench-hook on the bench and look down upon it.

You will see between the views some fine lines and some figures. The lines are made fine to distinguish them from the other lines. They terminate in arrowheads and are called dimension lines. The figures are for the purpose of giving the sizes and are called dimensions. These dimensions are not to give the size of the picture or drawing, but the size of the real bench-hook. Sometimes the drawing is made the size indicated by the figures, but more often the drawing is smaller than the object. In drawings for very small articles the drawing is made many times larger than the object.



Fig. 76—Jointing Edge in Vise

If you will apply your rule to this drawing, you will find that the side pieces which are marked 12 in. are actually just three inches long, or one-fourth the real size of the object. A draftsman would say that the drawing was made to the scale of one-fourth, or three inches to the foot. You can measure other parts of the drawing and find that it is all made to a scale of one-fourth.

At the right of the front elevation and the plan, is a third part of the drawing. This is called an end elevation. Although this is a small view it is quite important, for it shows one end of each piece and how they are placed together.

Read all the dimensions on this drawing before beginning work, and then dress up the 4-inch-wide piece on the four sides. As you do this work, see that every surface is worked and tested in the same order as the study piece. (Lessons 4 to 14.) As the piece is too wide to rest against the bench-stop, it may be held in the vise as shown in Fig. 76. If the stock which you have is too small to make a piece the size called for by the drawing, then make the piece as near these sizes as you can. Be sure, however, to always work to lines, gauging for both width and thickness.

LESSON 16

PLANING ENDS

After the piece is finished on all four sides, draw a knife line entirely around one end about $\frac{1}{32}$ inch from the end. (Figs. 64 and 65.) Place the piece in the vise so that the end will not be more than $\frac{1}{2}$ inch above the bench, as shown in Fig. 77. The piece is placed thus low in the vise

because it will plane easier. Take the smooth plane and sight the bottom (Fig. 12), to see that the bit is cutting at the center. Hold the plane as shown in Fig. 77 or 78. The picture shows the plane at an angle of about forty-five degrees. This is usually the best angle for cutting the grain, but some-



Fig. 77—Planing an End

times the plane will cut better if held at a different angle, or held parallel with the edges as in planing an edge or side. Unless you are certain that some other angle is better, you should hold the plane as shown in the pictures. Always move the plane parallel with the edge at whatever angle held.

There are three very important points to remember in

planing an end. First, do not plane entirely across the end; usually about two-thirds or three-fourths of the distance, and then either reverse the piece or step to the other side as shown in Fig. 78. Second, stop between every stroke while the plane is between you and the piece, (Fig. 79) and see exactly



Fig. 78—Planing an End

where you wish the plane to cut next. Third, always have a knife line to plane to, and stop so close to the line that there will be no unevenness, and yet the smooth, glassy surface made by the knife remain. This is not so difficult a matter as you may suppose, for if you will see exactly where each

shaving is to be cut, and move the plane so slowly that you can look into the mouth of the plane and see how it is cutting, you can make the end correct the first time. Test the end with the try-square, holding it against the side as in Fig. 80, and against the edge as in Fig. 81. Be sure to use the face-side and face-edge in making these tests.

If you fail to make the end true, read all of these directions again, then draw another line entirely around the piece not more than $\frac{1}{32}$ inch from the end and try again.

Continue studying the directions and re-lining and re-planing the end until it is made true. Remember it is not practice but study that will make possible doing the work right.

After the first end has been finished, measure the length



Fig. 79—Examining End

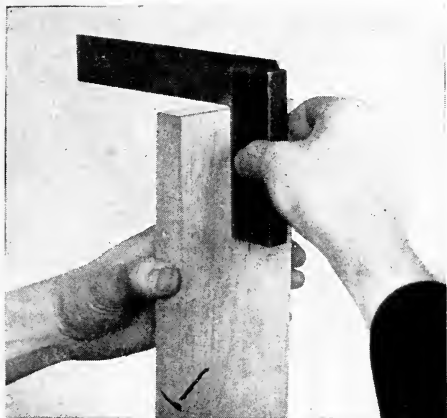


Fig. 80—Try-square on Side and End.

given in the drawing and draw a line around the other end of the piece. Saw about $\frac{1}{32}$ inch from the line (See Figs. 64 and 65), and then plane to the line.

You should be able to make this end square the first time trying, but if you do not, then re-line entirely

around the end and try again. Although to have the board shorter than the drawing calls for is a serious mistake and should not occur, yet it is far worse to leave the end without making it square and smooth.

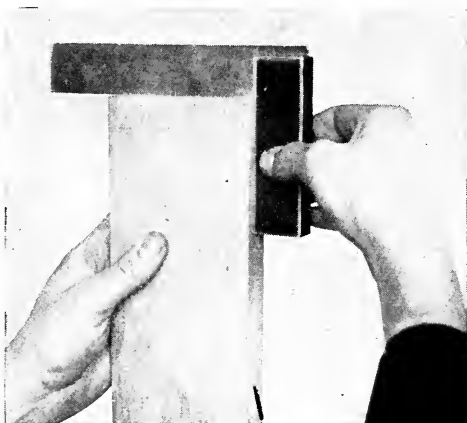


Fig. 81—Try-square on Edge and End

LESSON 17

MAKING THE SIDES.

After finishing the wide piece for the bottom of the bench-hook, take the piece which is $12\frac{1}{2}$ inches long and 4 inches wide, dress it square and finish the ends. Proceed exactly as directed in making the first piece. Make the piece as wide as you can, for it is to be ripped in two, and all the waste material may be taken from center. Do not plane it to less than $3\frac{1}{16}$ inches, for this will allow but $\frac{3}{16}$ inch waste for ripping, and unless you do very fine sawing you will require this for waste.

As this piece is to be ripped in two, you should place face-marks as shown in Fig. 82. This figure also shows lines



Fig. 82—Piece for Sides

drawn around the edges for chamfering. Draw the line for ripping by setting the gauge at 2 inches and

draw lines on both surfaces and across the ends from one face-edge; then set the gauge at $1\frac{1}{2}$ inches and draw the lines on both surfaces and ends for the $1\frac{1}{2}$ inch piece.

The piece is now ready to be ripped unless it is to be chamfered. The methods of chamfering are given in the next lesson. The following lessons on the rip saw and ripping should be studied before attempting the ripping. After the piece has been ripped, joint the edge of each piece. In case you have sawed beyond the line draw another line and plane to it.

LESSON 18

CHAMFERING.

A simple way of ornamenting a piece is to bevel the edges. When this is done as shown in Figs. 82 to 86, it is called chamfering. Such beveling of corners may be used in many places. Chamfers need not extend the entire length of a corner, but for the present we will consider only those which do, because these can be made with a common plane.

To do the chamfering, draw pencil lines around the board at an equal distance from the corners on the surface, and on the ends and edges. The chamfer may be on either the face-surface or the back-surface. For this piece the chamfer is on

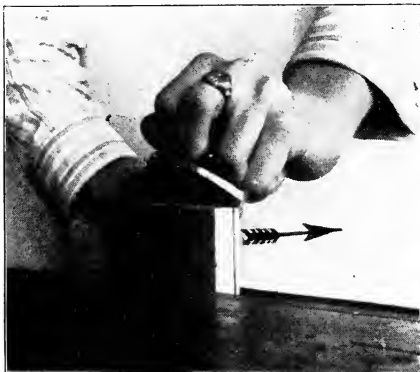


Fig. 83—Chamfering End

the face surface (Fig. 82.) Usually the lines are the same distance from the edges. In this drawing (Fig. 75) they are $\frac{1}{4}$ inch from the corners, therefore set the gauge at $\frac{1}{4}$ inch and draw the lines without changing the gauge, for in gauging for a chamfer we do not always hold the gauge against a face-surface or face-edge, but against the edges which are to be chamfered. This not only saves time, but is better, as we want the cham-

fers equal, and if we gauged all from the face-surfaces they would not be alike unless the piece were the same width at each end. Use a pencil in marking for chamfers and draw lines across ends as well as edges (Fig. 82).

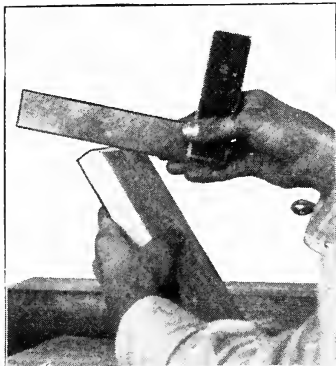


Fig. 84—Testing Chamfer

from line to line. Test it with the blade of the try-square as shown in Fig. 84.

Be careful not to plane beyond the lines; rather leave about half the width of each line.

After chamfering each end, place the piece as shown in Fig. 85 and chamfer the edges. In working the edges, the plane is held and

In working the chamfer, place the piece in the vise and hold the plane as in Fig. 83, that is, at an angle of about forty-five degrees with the edge. It should be moved parallel with the edge as indicated by the arrow.

Plane until the beveled or chamfered surface extends

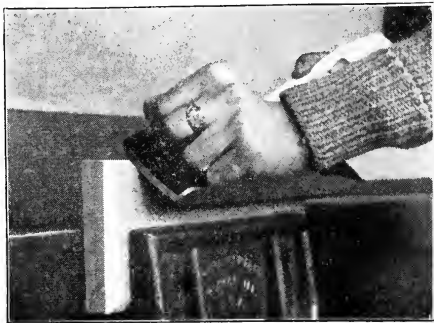


Fig. 85 Chamfering Edge

moved parallel with the edge. After both edges have been finished and tested as shown in Fig. 84, test all the chamfers by measuring, Fig. 86. They should all be of the same width; if they vary, see if you can find the mistake and correct it. Do not fail to make all the chamfers alike and straight from line to line, for such work is spoiled by even a slight irregularity or rounding of the surface.



Fig. 86—Measuring Chamfer

LESSON 19

RIP SAW AND HAND SAW.

The rip saw and handsaw may appear the same size and shape in a picture. Either style of back shown in Figs. 87 and

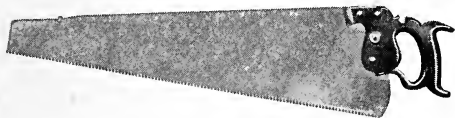


Fig. 87—The Common Grades of both Handsaws and Ripsaws are Made this Shape

88 may be used.

The difference is in the shape of the teeth. As the handsaw is for cutting across the grain the points of

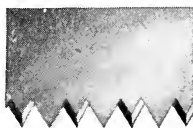
its teeth are shaped like the point of a knife blade. (Fig. 89A.)

The teeth of the backsaw are similar to those of a handsaw. The ripsaw which cuts lengthwise of the board has chisel shaped points to its teeth. (Fig. 89B.) Ripsaws are usually larger than handsaws.

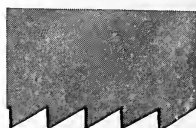


Fig. 88—Some of the Better Grade of Saws are Made this Shape

The fitting of saws is too difficult for you to undertake until you are familiar with the uses of the saws, as well as careful and precise with tools. When your saws require fitting take them to an expert in saw fitting. Do not think it sufficient to say that you want the saw filed, but tell what kind of work (rough or fine) you wish it for and the kind of wood; he will fit the saw for that particular work and also so shape the teeth that the saw will be more easily used by one who is not skilful in its use.



A—Handsaw



B—Ripsaw

Fig. 89—Teeth of Saws

LESSON 20

RIPPING.

There are two ways in which a piece of this size may be held in the vise for ripping. Probably the better way for the first attempts is as shown in Figs. 90 and 91. If the piece were wider it would be held as shown in Figs. 184 and 185.

Place the piece well down in the vise so that it will not be moved by the sawing. Begin at the front edge, starting the saw in the same manner as the back-saw in sawing the study piece. Be sure to start the saw on the forward stroke. (See Figs. 70 to 73.)

The most serious mistake you are likely to make in ripping is to saw too far from the line. If you saw far from the line because you fear you will saw into the line you will not have a sufficient guide for the saw and consequently will saw poorly. The rip saw should cut smoothly, therefore there is no need of sawing far from the line. You should plan to leave the line and a narrow strip at the side of the line.



Fig. 90 - Starting Ripsaw

This strip should be as narrow as it can be and not break away as the sawing proceeds. This need never be more than $\frac{1}{32}$ inch and may be less. If in ripping where both pieces are to be used, the amount of waste is more than required for one saw

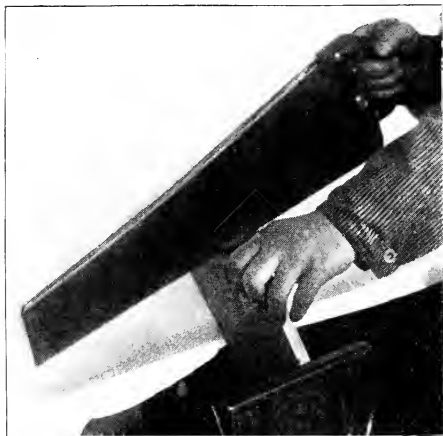


Fig. 91—Starting Ripsaw

reverse it as shown in Fig. 92. As soon as the saw nears the end of the kerf on the back side, reverse the piece again. This reversing of the piece should at first be done sufficiently often to avoid sawing on the side of the piece away from the worker. As the sawing becomes better understood,



Fig. 92—Piece Reversed

kerf, two kerfs should be made. Save time and avoid changing the piece in the vise so often by making both kerfs at the same time. After the saw kerf extends along the top end and a short distance down the side next to you, remove the piece from the vise and

the reversing need not be done as often. Continue sawing and reversing the piece until the ripping is completed.

As you near the lower end hold the piece as shown in Fig. 93, so that the vise need press the edges but lightly and thus avoid bruising them. If the ripping has been done properly

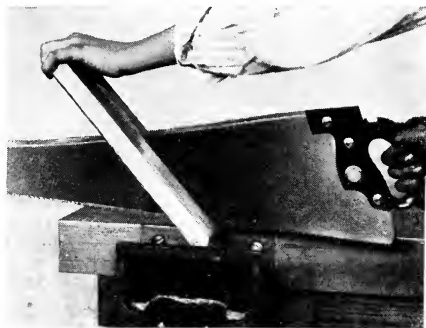


Fig. 93—Finishing Ripping

the edges will appear as shown in Fig. 94. This shows the markings made by the teeth of the saw at the different angles as the piece was reversed.

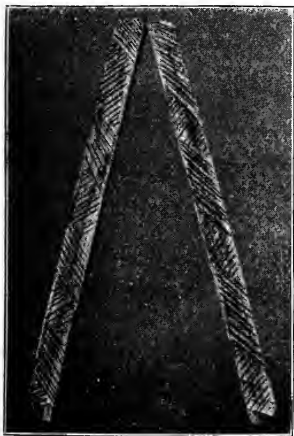


Fig. 94—Edges of Sawed Pieces

The edges should now be carefully jointed. Often it is best to remove the face-marks and place one on the side opposite the chamfer after examining the surface to see that it is correct; the edge should then be jointed to the new face-surface. The complete bench-hook (Fig. 74) shows the mark changed in this manner.

LESSON 21

NAILING.

The common adze eye hammer, (Fig. 95) is the only hammer required for your first work. The handle is hickory and the head steel. Both the face and the claws are tempered.



Fig. 95—Adz Eye Nail Hammer

The face, which strikes the nails, is tempered much harder than the claws. If the claws were very

hard they would be broken in use. The sides of the hammer head are so soft that they will bruise if struck against nail heads or other hard objects.



Fig. 96—Starting Nail

Lay one of the narrow pieces upon the bench and start a 6d wire nail as shown in Fig. 96. Drive the nail *just enough* to make it remain in place. Examine it carefully from two

directions, as in examining the bit, (Figs. 140, 141). If the nail is not at right angles to the surface as seen from each direction, move it with the fingers to the perpendicular, then drive it a *very little more* and examine it again. Be sure to drive the nail but a little at a time, to allow of placing it before it is so far in the wood that it will bend when you attempt to move it.



Fig. 97—Locating Nails

Start the four nails in this manner. The drawing (Fig. 75) indicates their location.

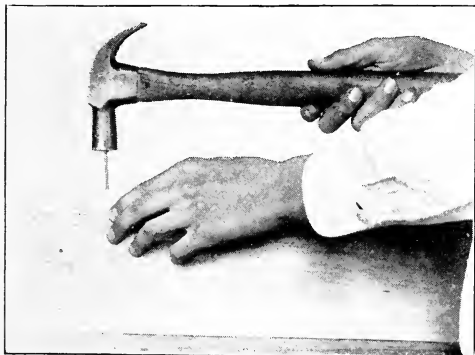


Fig. 98—Piece in Position

To determine how far from the edge to drive them, place the wide piece on the narrow one and then judge the center of the piece (Fig. 97.) Mark the location of the nail with a pencil.

Drive the nails so they will

prick through just enough to keep the piece from slipping when placed on the edge of the wide piece as in Fig. 98. Place the

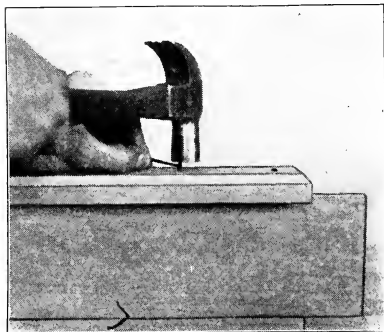


Fig. 99—Setting Nail with Nail Head

narrow piece so that its edge is even or flush, as it is called, with the face of the wide piece and drive one nail a little. Examine the piece carefully and if correct drive another nail a little. Continue driving the nails a little at a time and examining the piece to be certain that it is still in place. After the nails have been driven so the heads are flush with the wood, set them by using a nail as shown in Fig. 99, striking it hard enough to drive the heads about $\frac{1}{32}$ inch below the surface; or nails may be set by using a nailset, as shown in Fig. 100.

There are several styles of nailsets, the best for this work being shown in Fig. 101.

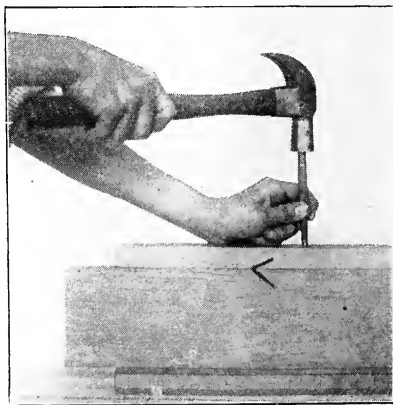


Fig. 100—Setting Nail with Nailset

Nail the piece on the other edge in the same manner. Look the bench-hook over to see that the nails are properly set and the edges flush. If



Fig. 101—Nailset

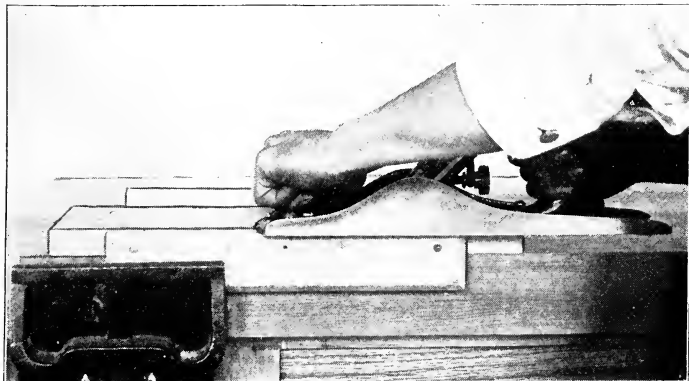


Fig. 102—Planing Joint Flush

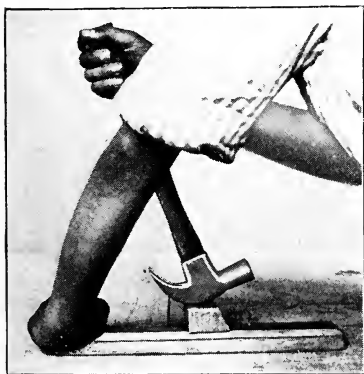


Fig. 103—Withdrawing Nail

the edges are uneven place the bench-hook in the vise as shown in Fig. 102 and plane a very little at the joint to make the pieces flush. You will see that it is much easier to smooth the joint when the edge projects beyond the surface than when it does not extend to the surface.

If you have occasion to withdraw a nail, a block may be placed under the head of the hammer as shown in Fig. 103.

LESSON 22

SHARPENING THE PLANE

Now that you understand something of how planes are used and the necessity of their being sharp you can try to sharpen them. Before doing anything to remove the plane iron examine all the parts carefully so that you will remember how they are placed and be able to return them to place.

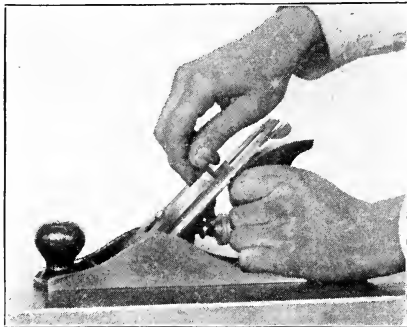


Fig. 104—Lifting Cam Lever

Before doing anything to remove the plane iron examine all the parts carefully so that you will remember how they are placed and be able to return them to place.

To remove the plane iron grasp the cam lever (Fig. 104) with the thumb and

finger and lift. This will loosen the cap, which can then be pulled endwise and removed. Next remove the plane iron,

place it on the bench and with a screw driver loosen the plane iron screw, (Fig. 105). Pull the plane iron cap to the position shown in Fig. 106

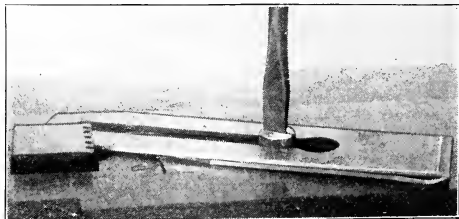


Fig. 105—Loosening Plane Iron Screw

and tighten the screw. Place the oilstone in the vise and grasp the plane iron as shown in Fig. 107. Rub it backward and

forward on the oilstone, holding it at exactly the same angle throughout the stroke.

The angle at which it should be held should be a little greater than that at which it has been ground, but must not be as great as the angle at which it is held in the plane.

To be sure you are getting the correct angle in whetting the plane bit, you may set the plane near the oilstone (Fig. 107)

and compare the angle at which the bit stands in the plane

with the angle at which you hold the bit while whetting it. You must always hold it at a less angle than the one at which it is held in the plane.

The angle made in grinding must be considerably less than the angle

at which it is to be whet so that in whetting you need not remove much metal.

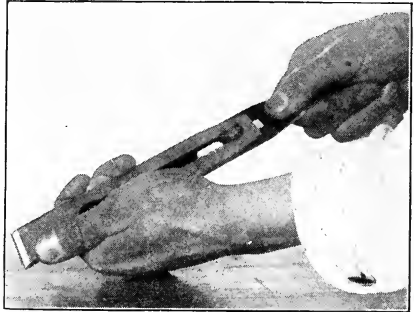


Fig. 106—Sliding Cap Iron

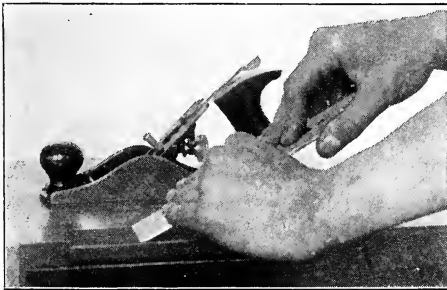


Fig. 107—Whetting Plane Bit

After you have become accustomed to using the planes and are strong enough to cut a wide shaving, the plane bit

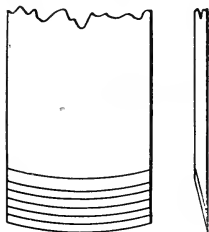


Fig. 108
End of Plane Bit

may be nearly straight across, but in your first work the bit should be quite rounding as shown in Fig. 108. In order to produce this rounding end hold the iron at the same angle thruout the stroke, but first press on one edge and then on the other edge.

In sharpening planes as in all other grinding and whetting of tools the position of the edge on the abraiding surface is

often altered to avoid inequalities in the surface. This usually necessitates the holding of the plane bit at an angle to the edges of the oilstone. If the surface is very rough or hollowed by long use or by careless whetting, the plane bit may be held nearly parallel with an edge. This will not give as good results and if time can be spared for truing the stone, it should be done.

At first you can examine the edge by looking for the fine, smooth part between where the stone is cutting and the extreme edge. As soon as this line disappears, test the edge first by drawing your finger on the flat side of the bit out over the edge as indicated by Fig. 109. This is to see if the edge



Fig. 109
Feeling for Wire Edge

has been turned or a wire edge formed. A wire edge is a fine thin bit of the edge which is so thin that it bends or turns to either side as the tool is rubbed over the oilstone.

Fig. 110 indicates the form of a wire edge and how it is produced. This wire edge is usually so fine that it is scarcely visible. It is very much exaggerated in the drawing in order to indicate its shape. So long as the wire edge remains the tool will not cut well. It may be broken off by rubbing on a piece of wood or on the oilstone. Usually the best way to remove a wire edge is to lay the plane bit on the flat side and move it against the edge as shown in Fig. 111. This may not remove the wire edge the first time trying. Be very careful in

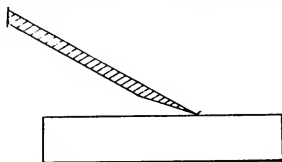


Fig. 110—Sketch of Wire Edge



Fig. 111—Removing Wire Edge

rubbing the plane bit on the flat side to hold it down flat on the stone, for if you do not, a small angle will be made on this side of the edge which will do much harm. It will likely turn the edge as indicated by the sketch. (Fig. 112.)

Hold the iron again as in Fig. 107 and move it forward, pressing very lightly and being careful to hold it at the same

angle you did in whetting it. This will again turn the edge as indicated by the sketch, Fig. 110. Continue to rub the edge lightly, holding it first as in Fig. 107 and then as in Fig. 112 until the wire edge is removed. Examine it often both



Fig. 112—Wire Edge Reversed

by looking at it and by drawing the finger over it as in Fig. 109. Sometimes you may need to draw the finger over each side in order to find out which way

the edge is turned. Watch carefully to see that the wire edge is removed entirely across the end. It often breaks away at the center without breaking away near the corners.

As soon as you think the edge is sharp, hold the iron as shown in Fig. 113 and test it by drawing the ball of the thumb over it. If it is sharp it should easily cut the outer coating of the skin. If it does not appear to be sharp, rub it again on the oilstone, this time rubbing lightly but at the same angle as at first. Another way is to test the edge on a piece of pine. If the cut shows a clear, glassy surface, the edge is sharp. This is a good test after testing it on your thumb, so do not depend upon the wood test but learn to test it with your thumb, for it is much easier and quicker.



Fig. 113—Testing Edge

After finishing on the oilstone the edge may be improved by rubbing lightly upon a piece of leather (Fig. 114) as it was rubbed on the oilstone, except that it is lifted from the leather or strop on the return stroke and is rubbed *away from the edge* as indicated by the arrow.

When you are sure that the edge is sharp, place the plane iron cap in position, its lower end about $\frac{1}{32}$ inch to $\frac{1}{16}$ inch above the cutting edge. Put the iron in place and the cap over it and press down the cam lever.

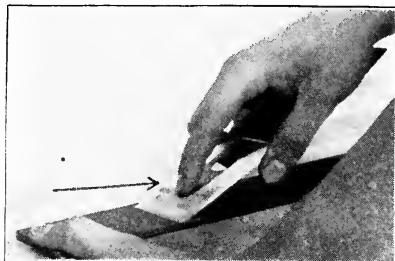


Fig. 114—Stropping Plane

Hold the plane as shown in Fig. 11 and turn the milled thumb-nut until the cutting edge projects a very little below the bottom of the plane. Try it on a piece of scrap wood and keep turning the thumb-nut or adjusting the lever, Fig. 11, until it cuts a fine shaving at the center of the plane bottom.

LESSON 23

GRINDING THE PLANE BIT.

After the bit has been whetted several times the end becomes so blunt that it cannot be easily sharpened in this manner. There is so much metal to be removed that it requires too much time and the angle at which you must hold it will be so near the angle at which the iron is held in the plane that it will not cut when sharp.

To remove this large amount of metal the iron is held on a revolving stone which cuts much faster than the oilstone. The iron should be held free-hand against the grindstone as shown in Fig. 115.

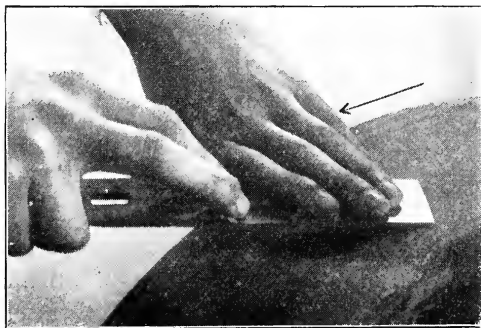


Fig. 115—Grinding Plane Iron

Do not attempt to grind the edge sharp enough for use, but remove the larger part of metal, and then refine the edge with the oilstone. Be sure to have plenty

of water on the grindstone so that the plane bit will not be injured by the heating of the thin edge while grinding. Be sure to wipe all moisture off the plane bit and cap iron before returning them to the plane.

LESSON 24

CUTTING BOARD

Fig. 116 is a drawing of a cutting board with plain edges. Fig. 117 illustrates a cutting board with chamfered edges. The two are typical of boards used in cutting bread or meat and, in larger sizes, for kneading bread, molding pastry, etc. The processes used in making them are much the same whatever the size, unless so large that two or more pieces of lumber are required for one board.

If you have, before beginning on this board, made the first study piece, (Fig. 66) and the bench-hook (Fig. 74) you should be able to make a cutting board, or any similar board, as well as a good mechanic.

Make a complete scale drawing of the board you wish to make. Be careful to fol-

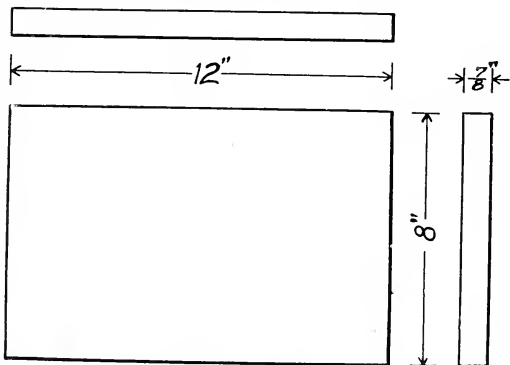


Fig. 116—Cutting Board



Fig. 117—Cutting Board

low all directions and when you come to a reference, look up and study it until you fully understand it.

Select the best side of the board for the face-side and plane it true, testing and planing as in Lesson 4 on planing the first surface of the study piece. Follow directions in Lessons 4 to 17, excepting as changes are desirable on account of the size. In planing a wide piece it is usually better to place it *across* the bench and plane crosswise of the grain

as shown in Fig. 118. The plane is moved straight across the piece, but *held* at an angle. The amount of the angle and the direction is determined by the way of the grain. Cross planing should usually proceed very systematically and after each cross planing the piece should be turned and planed in the usual manner.

If the board is in wind, you should plane diagonally a part of the time, planing most at the high corners.

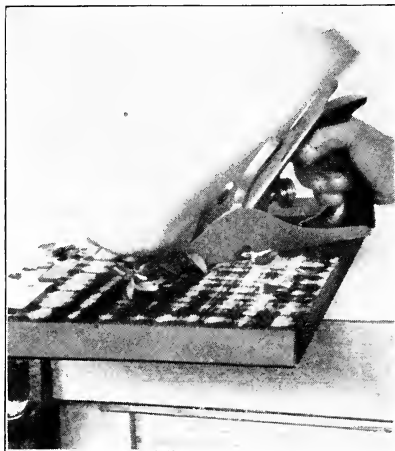


Fig. 118—Cross Planing

The second edge is worked in the same manner as the second edge of the bench-hook piece, (Lesson 15) unless the piece is too wide for your gauge. Some gauges have long beams arranged for wide pieces, but you will have so little use for a large one that you had better work the piece without the gauge if yours is too short. Lay the piece on the bench,

and mark the width at each end as shown in Fig. 119. If you have a straight edge, you can draw a pencil line from mark to mark. This will be necessary if you are to rip the piece. Figs. 184 and 185 show how to hold a wide piece in ripping. If there is but little to be dressed off, you can plane from end to end until the edge has been worked to the line or the two marks.

Next gauge the thickness of the board and dress the opposite side. In working such pieces where usefulness is not impaired by variation in thickness it is usual not to be particular to make them the exact thickness the drawing calls for, but to set the gauge to the thinnest corner and work the piece to that thickness.

Finish the ends the same as the ends of the bench-hook (Lesson 16). Be sure to draw the knife lines entirely

around them and plane exactly to the lines. This finishes the board, unless it is to be chamfered, with the exception of sandpapering. Directions for sandpapering are given in lesson 25. If you wish to chamfer the board read the directions for chamfering the sides of the bench-hook (Lesson 18).

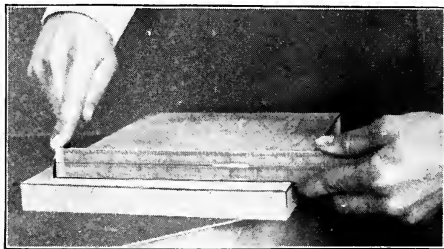


Fig. 119—Measuring Width of Board

LESSON 25

SANDPAPERING

There are a number of kinds and grades of sandpaper. The only kind required for your first work is what is called flint paper or sandpaper. The grades you require are, Nos. $1\frac{1}{2}$, 1, $\frac{1}{2}$ and 0. There are coarser and finer grades than these, but they are not needed for ordinary work. No. $1\frac{1}{2}$ is coarser than No. 1. No. 0 appears to be almost smooth. These papers are made by covering the paper with a coating

of glue, and then with a coating of some abrasive substance, such as ground flint. The paper is very tough, and if properly held will stand a large amount of rubbing.

Before the paper is used, the surface seems to cut the hand it is rubbed over. A little use of the paper on wood partly fills the cutting surface with wood dust and makes it cut smoother. Sandpaper which has been used is often better than new for finishing. You will find it an essential to the best work as well as a matter of economy to use sandpaper until it is worn out.

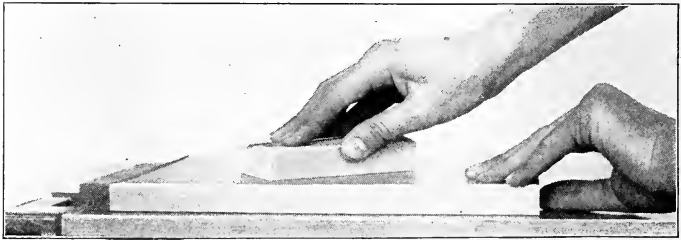


Fig. 120—Sandpapering with Block

To do this you should settle upon a certain size piece and always tear the paper to that size unless the nature of the work prevents. The small pieces of the original sheet are used either on a block or in the hand. When a block is used the paper should not be fastened to it but held in position by the hand as shown in Fig. 120. There are many places in which a block should not be used. A block is as a rule used only upon large surfaces. If no block is used, the sandpaper is manipulated with the hand and fingers. Whether used on a block or in the hand, it should be torn in the same manner and to the same size.

The ordinary size of a sheet of sandpaper is 9 inches by $10\frac{1}{2}$ inches, and it should usually be torn into four pieces, each $4\frac{1}{2}$ inches by $5\frac{1}{4}$ inches. This is done by laying a sheet, rough side down, upon the bench top, placing a back-saw or some other small saw across the sheet at the center and then pulling up at one corner, as shown in Fig. 121. Do not use the rule in determining the center of the sheet, but place

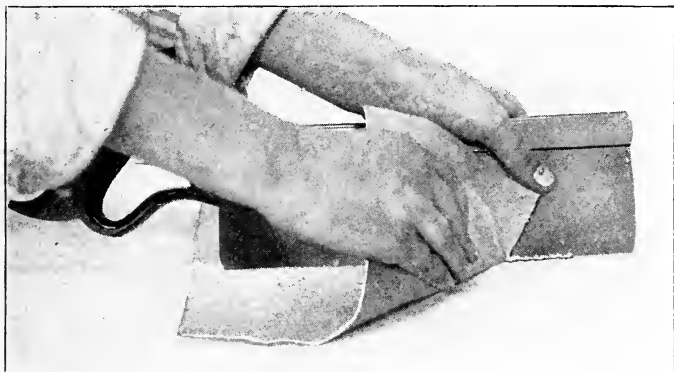


Fig. 121 - Tearing Sandpaper

the saw as near the center as you can judge. Tear each half again and you will have four pieces of proper size for use.

Just what grade of paper should be used cannot be stated until one knows the kind of wood, and how smooth the planing has been done. Usually No. 1 or No. $\frac{1}{2}$ is coarse enough for surfaces and edges, and No. $1\frac{1}{2}$ or No. 1 for ends. If the work is to be nicely finished these should be followed by finer grades. Sometimes this is continued until No. 0 is used, but usually two grades are sufficient. Only by experimenting

will you be able to select the proper grades for your work. Soft wood usually requires finer paper than hard wood. To produce fine finish for polishing No. 00 paper is required.

In sandpapering the cutting board (Fig. 116) finish first the under and then the upper surface. Use the paper on a block as shown in Fig. 120, moving it lengthwise of the grain. Be very careful not to work too near the ends or edges. If you rub much too near the edges, the outline will be



Fig. 122—Sandpapering Surface with Hand

spoiled, for the paper cuts faster at an edge than in the center of a surface.

After you have done what you can with the sandpaper on a block, lay the block aside and take the piece in your hand as shown in Fig. 122. Examine the surfaces especially near the edges and smooth any spots that were not properly smoothed with the sandpaper on the block. Next hold the board and paper as shown in Figs. 123 and 124 and smooth the edges.

Be careful not to round the corners, as this is a mark of a shiftless workman. To avoid this the hand must not rest flat upon the edge but at an angle as shown in Fig. 124. Do not



Fig. 123—Sandpapering Edge with Hand

retain the fingers in the same place on the sandpaper, but change their position often. Sometimes the sandpaper is held as shown in Fig. 125, but usually a block is not required



Fig. 124—Sandpapering Edge with Hand

on the edges, and if used it should be thinner than the edge to be sandpapered. Fig. 132 shows such a block. Sometimes the work is held in the vise and the sandpaper is held with both hands as shown in Fig. 126.

The chamfer is sandpapered in the same manner. Because a chamfer is narrow and because it is important that the edges



Fig. 125 - Sandpapering Edge with
Narrow Block

remain sharp, much care is needed to sandpaper it properly. Fig. 127 shows how this is done.

In your first attempt at sandpapering, stop frequently and examine the wood with the rule and the trysquare and you will note with surprise how rapidly the surface is changed by the sandpapering. If you do the work properly, the surfaces will be as square and true to the edges as before.

If by mistake or carelessness you have injured the true outline of the edges, you

had better replane the surfaces and try sandpapering again. Be *very careful not* to make such a mistake, for after sandpaper has been used, particles of grit remaining in the pores of the wood will rapidly dull the plane.

In sandpapering a small end, place a piece of sandpaper on a smooth surface and hold the piece vertically and firmly

upon it as shown in Fig. 128. Notice that the fingers are close to the lower end. Move the piece from you, lifting it from the paper on the return stroke. Go slowly, being careful that the top end does not move about. Test the end with the try-square and you will discover that the sandpaper cuts faster on the edge farthest from you. This necessitates turning the piece after every few strokes. Do not attempt to remove much material in this manner, for if you do the end will be rounded and there is no easy way of squaring it.



Fig. 126—Sandpapering Edge with Both Hands

In sandpapering cylindrical pieces, the paper is folded

around the piece and held as shown in Fig. 129 and moved lengthwise of the piece. Sometimes it is better to revolve the piece in the paper at first. The finishing should always be done by moving the paper with the grain of the wood. One diffi-

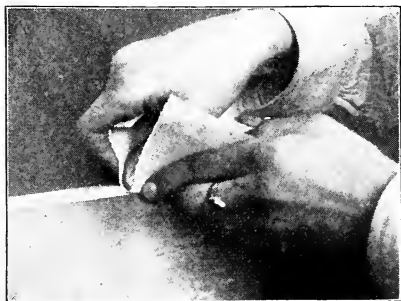


Fig. 127—Sandpapering Chamfer

culty about sandpapering such work is to avoid slanting the surfaces near the ends; therefore rub the paper over the ends less than you do along the center. In all sandpapering, watch to see how much the paper is cutting.



Fig. 128—Sandpapering End

The proper grade of paper to use depends so largely upon the kind of wood, size of cylinder and the planing that you must determine the grade by trial.

Begin with too fine rather than too coarse a paper. If it does not cut down the plane marks, try a coarser grade. Use the coarser paper only enough to remove the plane marks. Follow with finer grades until the desired smoothness is produced.

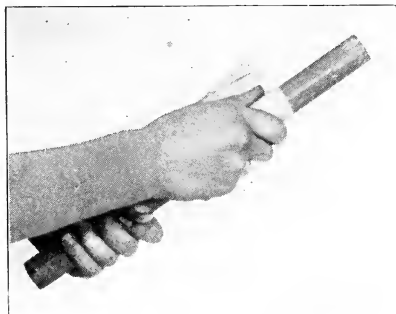


Fig. 129—Sandpapering Cylinder

The sandpapering of a rounded edge follows much the same plan as the sandpapering of a cylinder. It consists of two distinct operations—first, the removing of the plane marks and second, the smoothing of the grain of the wood.

As the paper cannot be folded around the edge without injuring the surfaces it is held on a block and the block moved across the plane marks at the same time it is moved lengthwise. See Fig. 130. This has much the same result as rolling the cylinder in the folded sheet of paper.

After the plane marks have been removed in this way (Fig. 130) the edge is rubbed lengthwise with the sandpaper first on the block and then in the hand. More than



Fig. 130—Sandpapering Round Edge

one grade of paper will be required to give a proper finish.

As you work with sandpaper you should watch the appearance of the surface to learn how the different grains of wood are affected by the rubbing. You should compare the effect of sandpapering on hard wood and on soft, on end grain and lengthwise of the grain. Notice also how the paper cuts the medullary rays of oak and the porous grain about the large rays.

In sandpapering woods having a hard close grain, alternating with a soft porous grain, the sandpaper must be used without a block, for a block will cause the soft porous grain to be

cut below the harder grain and a proper finish will be impossible. For such surfaces all sandpapering must be with the sandpaper carefully folded beneath the fingers and nearly all the rubbing done upon the firm parts of the surface. This requires so much skill that woods having great contrast in grains should not be used in elementary school work. Such use is certain to give incorrect ideas of finishing and to do much harm.

Lastly and most important, see how little rubbing, carefully done, will produce the smooth satiny surface suitable for receiving the finish. He who gets the result with the fewest motions is the best workman.

LESSON 26

SANDPAPER BLOCK

Fig. 131 illustrates a rectangular block for use on flat surfaces. See Fig. 120. The block with the thin edge (Fig. 132), may also be used on a flat surface, but is especially adapted for narrow spaces or edges.



Fig. 131
Rectangular Block

Fig. 133 will be found convenient for use in corners and in smoothing rounded ends after they have been whittled.

Fig. 134 is for large hollows or internal curves. All of these forms should

be carefully made, all surfaces being straight and square, true angles or curves. Follow the directions given for planing surfaces, ends and edges in first lessons.

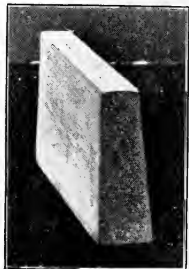


Fig. 132
Block for Use on Edge

These blocks are usually made about $4\frac{1}{4}$ inches long, $2\frac{1}{4}$ inches wide and $\frac{7}{8}$ inch thick. The paper should not be fastened to the block, but held in place by the hand.

Sometimes a soft pad is placed between the block and the paper, but generally this is not best. A pad makes possible the smoothing of uneven surfaces without working

them down to a true surface.

This is often an ad-

vantage on cheap commercial work, but usually should not be used in school work. The straight smooth block, if properly used, will produce a better surface, especially on woods having a coarse grain such as oak or mahogany.



Fig. 134—Block for Use in Large Curves



Fig. 133—Block for Use in Corners and in Small Curves

LESSON 27

COUNTING BOARD

The counting board is scarcely more than a study piece, for such boards are so seldom used that their value is really nothing.

As a study piece the counting board is of considerable value if it is made according to the drawing. (Fig. 136.) Do not make it less than 11 inches long, for if you attempt to

plane a piece which is much less than 11 inches long before you have a better understanding of the principles of planing, you will likely form bad habits and get erroneous ideas of using the plane.

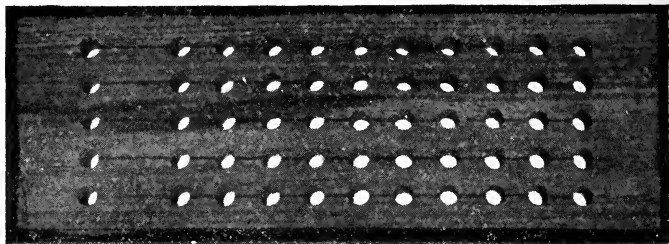


Fig. 135—Counting Board

If you have been very successful in end planing you can cut the corners as indicated by the dotted line on the drawing. If you wish to do this, read all that is said about cutting corners in Lesson 29.

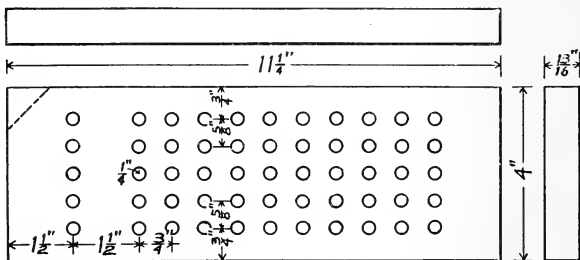


Fig. 136—Counting Board

The chamfering is done as directed in Lesson 18. Be sure to make every chamfer straight and of correct size. Keep all the corners sharp.

To locate the holes, draw pencil gauge lines parallel with the face-edge. Lay off on one of these lines the spacing for the holes and with a try-square and knife draw short lines across each gauge line, locating the holes. If this is done properly, there will be exactly fifty places marked for boring, besides the five tally holes at the top. Lesson 28 gives directions for boring.

LESSON 28

BORING

There are other things requiring attention in boring holes besides making the brace go around. If you will study each thoroughly and in its proper order you will soon bore holes quite as well as the ordinary mechanic, though you may not work as rapidly.

First examine the bit and learn the purpose of each part. The

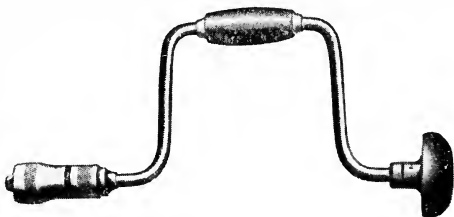


Fig. 137—Bit-brace

square upper end, or tange, fits into the bit brace, and the round part or shank, gives length so that deep holes can be bored. The common auger bit and the dowel bit differ



Fig. 138—Auger Bit

only in length. Dowel bits, being easier for the beginner to use, may be used in all boring not requiring the longer bits. There are many shapes

and sizes of bits but at present we will consider only the auger bits.

There are three important parts at the cutting end of the bit (Fig. 138). The screw *B* helps to place the bit and pulls it into the wood. The spurs *AA* cut across the grain of the wood and the lips *CC* cut at the bottom of the hole.



Fig. 139—Setting Bit

The sleeve is then turned in the opposite direction until the bit is held tight.

The placing of the screw is of considerable importance. In order to see the point and the lines the bit is held obliquely as shown in Fig. 139, but before pressing the screw into the wood the position is changed to vertical (Fig. 140). Then turn the brace not more than once in the direction in which the hands of a watch move. Observe the position of the bit and brace. Are the angles formed with

All bits are held in the brace in the same manner. By turning the milled sleeve at the lower end of the brace (Fig. 137) the jaws are opened to receive the tange and shank.



Fig. 140—Boring

the surface of the piece right angles? After judging with your eye place the try-square as in Fig. 142. same position and step to the end as in Fig. 141.

Examine the bit again looking for the right angles the same as before. Move the try-square to the side and see if you judged correctly. Turn the brace another turn and repeat the two tests. Be careful to examine the bit from just two positions, one at the end and one at the side of the piece. Continue turning the brace and examining to see that it is boring at right angles to the surface until the hole is completed. Each succeeding hole should require less examination, until two or three changes of position are ample.

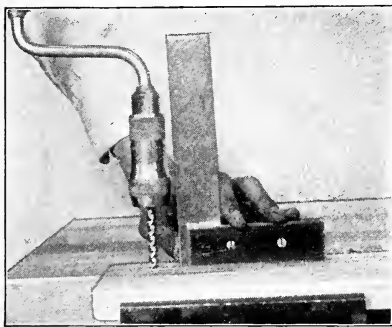


Fig. 142—Try-square at Side of Bit

After judging with your eye place the brace in the



Fig. 141—Boring

Use the try-square less and less until you can do the boring without it. Bore the holes until the screw pricks through, then turn the piece over and finish the holes from the opposite side. Be quite as careful in finishing as in starting the holes.

LESSON 29

BREAD BOARD

The first work on Fig. 143 is the same as on Fig. 116. Next, the end is laid out by locating the four points at the end and edges according to the drawing (Fig. 144) and drawing knife lines to these points. To use the try-square, hold it as shown in Fig. 145, where the head at the blade touches the piece. Do not attempt to hold it without having the head in contact with the edge.



Fig. 143—Bread Board

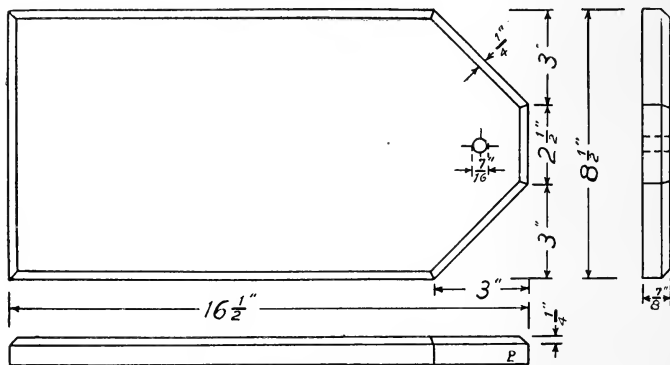


Fig. 144 - Drawing of Bread Board

try-square in the ordinary manner or the gauge may be set and pencil lines drawn as shown in Fig. 146. This affords points at which lines may be drawn on the back or under surface.

Saw the corners to near the knife lines, holding the piece on the bench-hook as shown in Fig. 147. After sawing, plane to

the lines the same as in planing an end. You will notice that the more slant to the corner, the less need there is for the

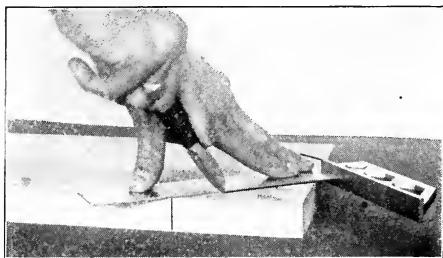


Fig. 145—Lining Corner

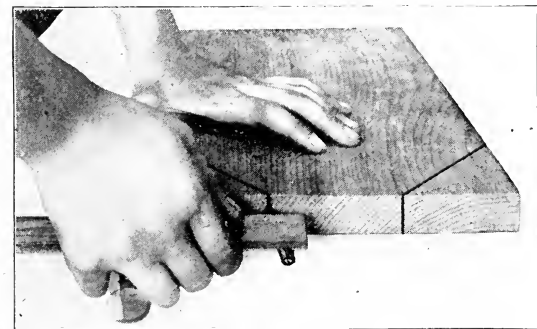


Fig. 146—Gauging Corner

plane to be held at an angle. If the edge is tapered very much the plane should be held parallel with the edge. Fig. 148 shows how the piece is held in planing the corner. This piece may have square edges, or chamfered edges. If they are to be cham-

fered the plane should be held parallel with the edge. Fig. 148 shows how the

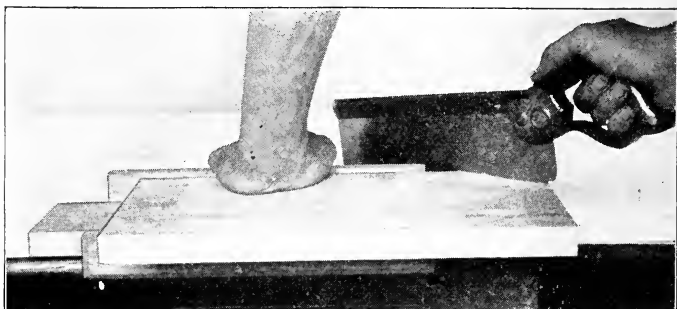


Fig. 147—Sawing Corner

ferred, follow the directions in Lesson 18. A common mistake in chamfering such pieces is to make the chamfers too large.

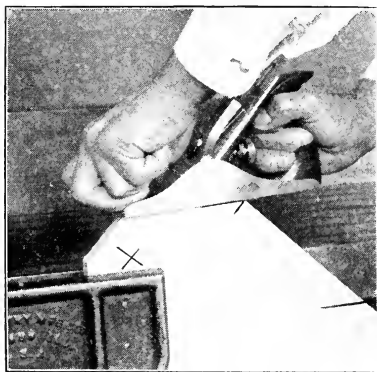


Fig. 148—Planing Corner

They should be not more than $\frac{1}{4}$ inch. Be careful to use a well sharpened pencil point in the gauge and then work exactly to the lines. If you wish to have a hole by which to hang this board, locate it by measuring as indicated in the drawing, Fig. 144.

Bore the hole, following the directions given in Lesson 28.

LESSON 30

ROUNDING AN EDGE

Fig. 149 is a view of a rounded edge. Such edges may be used on boxes and many other articles as well as on the bread board. (Fig. 143.)

To round the edge, after it has been squared, draw a pencil line along the center with a gauge and a line on each surface, with the gauge set at the same space. The rounded surfaces are formed with a plane used and held as in making a chamfer. (Figs. 83 to 85.)



Fig. 149—Rounded Edge



Fig. 150—Section of Round Edge

The difficulty in rounding an edge is the opposite of that in chamfering.

While making a chamfer you found it difficult to make the surface straight from line to line; in making the rounded edge, you will make it too straight, unless you attend closely to the form.

Fig. 150 illustrates the difficulty by showing an edge, the darkened portion indicating the material to be removed in rounding it. By examining this illustration you will see that very little of the stock is cut away near the lines and that much less is removed than would be if a chamfer were made between the same lines.

LESSON 31

SHELF

The making of a shelf requires much the same directions as the making of a cutting board. Usually a shelf, because longer, requires additional directions. Before making a shelf read the directions for planing in Lessons 1 to 11 and those for making the cutting board. The only additional directions you will require are those for planing long pieces, trimming corners and planing long curves.

When a piece is too long to be planed at one stroke with the foot in one position, one of two methods may be used. If it is an edge, and sometimes when it is a wide board, which is to be planed, the plane is started in the usual way and then kept moving by taking one or more steps so that the plane passes the entire length of the piece. The other method, which is usually followed in planing long wide surfaces, is to plane them by sections. This is done by beginning on one corner and working across; then planing another section, and still another, in a similar manner, until the entire surface has been planed.

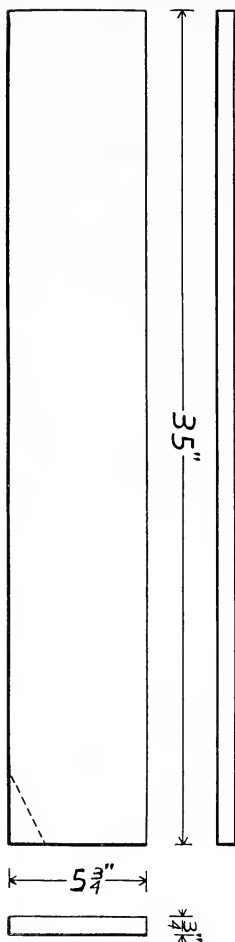


Fig. 151—Shelf

Fig. 152 represents the first section planed. Fig. 153 represents the second section planed. Fig. 154 represents the

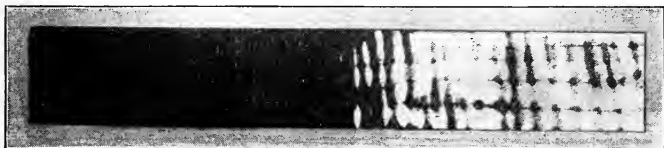


Fig. 152—First Section Planed

surface after it has been planed the entire length, the shaded portions indicate where the plane was raised and lowered. The

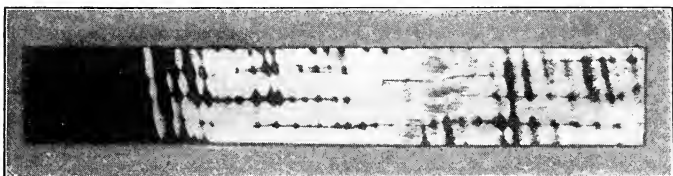


Fig. 153—Second Section Planed

darkest places show the low spots in the surface of the board. These are removed by again going over the surface systemati-

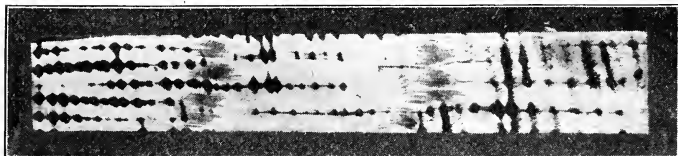


Fig. 154—Third Section Planed

cally. In finishing the surface the plane should be set very fine and the shavings taken so carefully that there will be no

visible marks where the plane begins to cut or where the shaving runs out.

The shelf may be dressed on both surfaces in the same manner. The edges should be finished by taking a shaving the entire length. In sawing pieces of this length they may

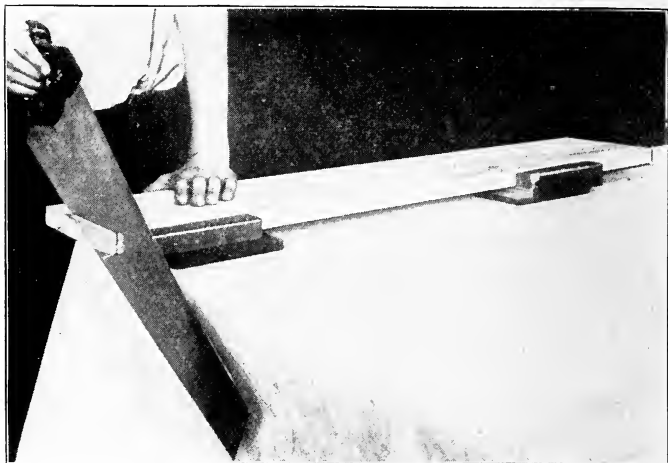


Fig. 155—Sawing Ends

be held on the bench by using two bench-hooks as shown in Fig. 155. Finish the ends the same as the large piece of the bench-hook (Lesson 16). The corners of this shelf may be cut off where indicated by the dotted line; being done as in making Fig. 143.

LESSON 32

SHELF

The new feature of this shelf (Fig. 156) is the curved edge. The edge may be lined either free hand on the surface, by making and using a pattern, by use of a strip of wood and two nails, or a nail and a pencil, as shown in Fig. 157.

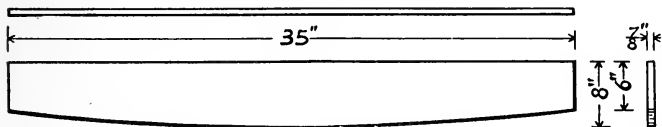


Fig. 156—Shelf

The nearer straight you wish the curve the greater the length of the stick or bar must be. In your first attempts at drawing such curves, you may guess at the length of the rod. The

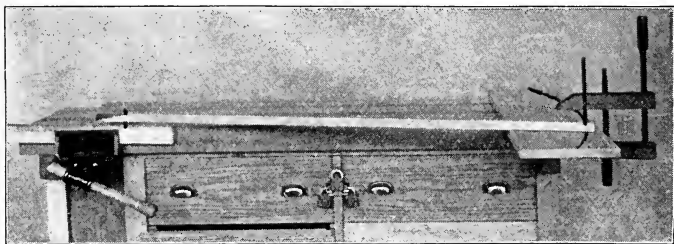


Fig. 157—Drawing Circle

curve made by the pencil in moving over the shelf is called an arc of a circle. The distance from the pencil to the nail is the radius of the arc.

This distance or radius is one-half the diameter of a complete circle having the same curvature as the shelf edge.

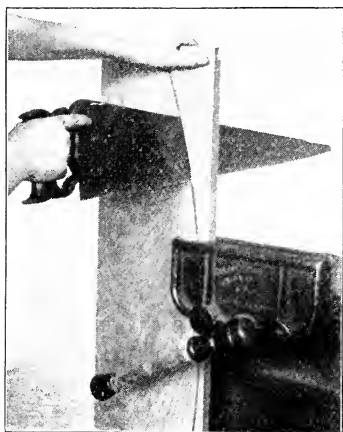


Fig. 158—Ripping Curve

If you have a narrow rip-saw with a wide set to the teeth, you can begin at one end of the shelf and rip along the curve, ripping off the waste material as shown in Fig. 158. Notice that the rip-saw is held nearly horizontal. If you have no such saw, draw straight lines tangent to the curve and rip to them.

After ripping, smooth the edge with a plane as shown in Fig. 159. You will find the plane a good tool for working such curves.

Be careful to plane to the line, for any short variation from the true curve will show badly. This shelf may be chamfered as shown in Fig. 117 or rounded as shown in Fig. 149.

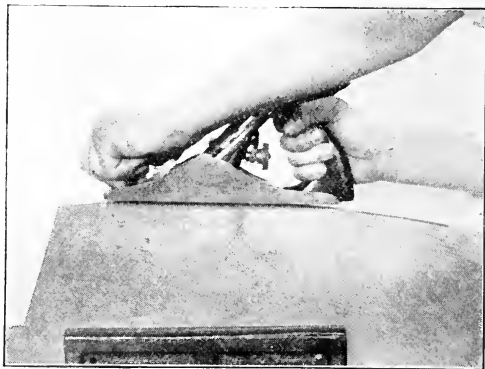


Fig. 159—Planing Curve

LESSON 33

MANTEL SHELF

If you have made successfully all the pieces up to Lesson 30, you should be able to make this shelf. Work each piece to the sizes given in the drawing, (Fig. 162)



Fig. 160 — Mantel Shelf

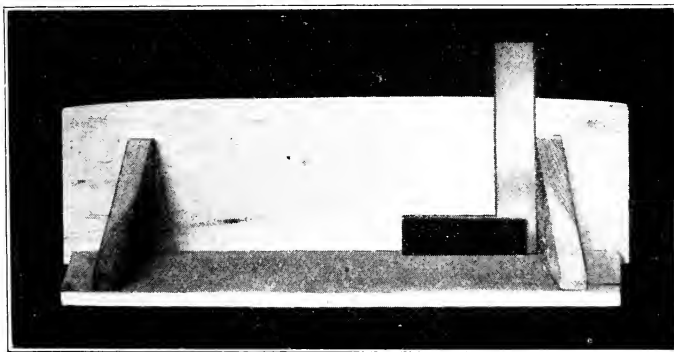


Fig. 161 — Testing Angle of Brackets

By making the shelf supports or brackets in one piece as shown in Fig. 163 and then cutting them apart, you will be

able to make them nicer and in less time than by working each piece separately.

The holes in the back for fastening to the wall should be 16 inches from center to center. This is to make the holes correspond with the centers of the studding in an ordinary frame house. In any change of size or form which you plan you should keep this space the same or use some multiple

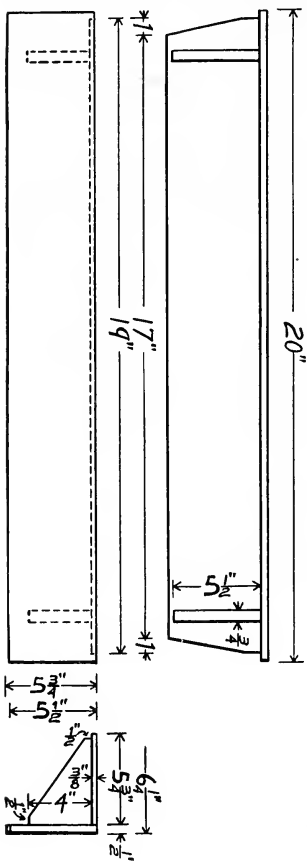


Fig. 162—Mantel Shelf

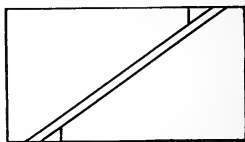


Fig. 163
Laying out
Brackets
in one Piece

of this space. The outline may be modified in many ways and yet the shelf be made with such tools and processes as you already understand.

In fastening the parts together, first fasten the brackets to the back and then fasten the shelf to the back and brackets. Test the position of the brackets by placing a try-square in each corner as shown in Fig. 161.

LESSON 34

SWING BOARD

A swing board though apparently a simple thing to make and one which can be undertaken at any time is by no means as simple as it appears and should not be undertaken until all the work up to Lesson 29 has been successfully accomplished.

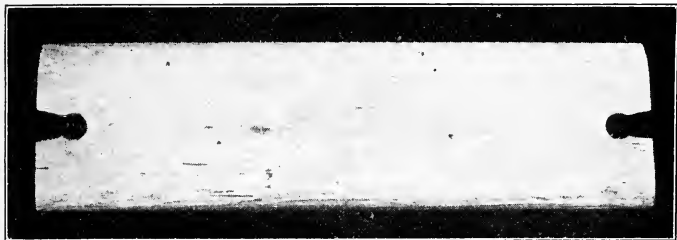


Fig. 164—Swing Board

In making the board (Fig. 164) follow the directions for planing out of wind, jointing edges, etc. given in these lessons.

To work the oval edges draw pencil lines with the gauge

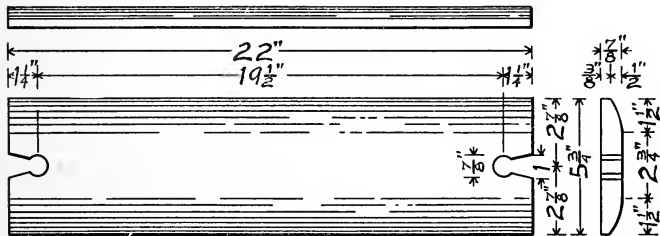


Fig. 165—Swing Board

on the two edges $\frac{1}{2}$ inch from the face-surface and on the face surface $1\frac{1}{2}$ inches from each edge. These lines are at the edges of the shaded portion in the drawing, (Fig. 165). Form the edges by planing, following the directions for rounding edges given in Lesson 30.

Lay out the holes and notches at the ends. Bore the holes from each side. (See Lesson 28.) Saw out the triangular pieces, using a rip-saw and sawing *on the* lines with great care, as the surface is left just as sawed. Notice that the V shaped opening is formed so that the rope slips through a space narrower than the diameter of the hole.

LESSON 35

FOOTSTOOL

This is the most simple form of footstool. Its beauty lies in simple outline and perfect finish. Be sure to select lumber which will finish nicely. Oak with large medullary rays is suitable. Whatever wood is used, the top should be quarter sawed so that it will not warp.

In making the top, follow the directions given for making the cutting board, (Fig. 116). Be careful to make the surface true and smooth. After planing it as directed in making the cutting board there may still be uneven spots or torn grain. Sharpen your plane, set it as fine as you can and go over the top surface and edges systematically.

If this does not make it sufficiently smooth for sandpapering you must use a scraper. For directions for using a scraper see Lesson 36.

The legs are first squared in one long piece and then cut

to length. The scraping and sandpapering should be done after the doweling or inserting of the screws has been finished, for, in this latter work, the surfaces may be marred and if the scraping has been done, it would need to be done over again.

Either of two methods of securing the legs may be used. The more common way is to use dowels, as shown in Fig. 170.

If dowels are to be used place the legs in position, *one at a time* as shown in Fig. 167, the face-marks toward the inside, and make two marks at the end of each *outer surface* of each leg, holding the knife as shown, making the marks clearly on both the legs and

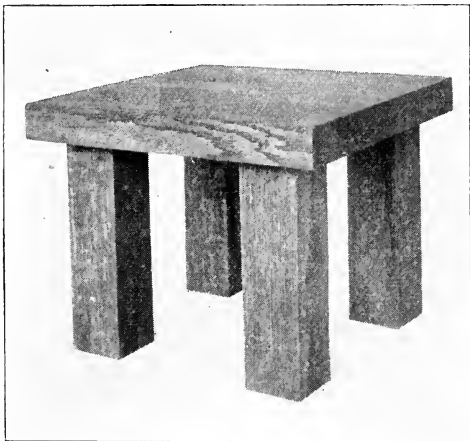


Fig. 166—Footstool

the top. Also number each leg and the corresponding place on the top so as to replace them in the same positions.

Set the gauge to each mark as shown in Fig. 168 and draw lines across the ends of the legs. Place the knife point in each mark on the top and draw lines as shown in Fig. 169.

The points at which these lines cross, on both legs and top indicate places at which to bore the holes for the dowels.

Bore the holes in the top as deep as you can and not leave

a mark from the spur of the bit. Bore the holes in the ends of the legs about 2 inches deep. Glue the dowels into the top

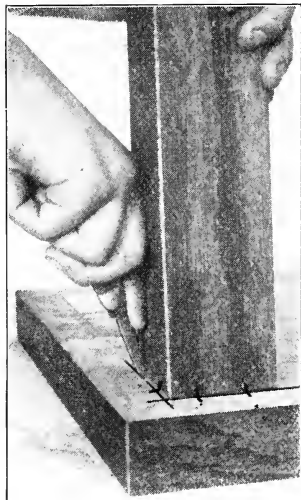


Fig. 167—Marking for Dowels

and allow the glue to dry, then glue them into the legs. Fig. 170 shows them in place and the leg ready to be driven down tight to the top. It is often easier to force the dowels into place by clamping instead of driving. If but one dowel is used in each leg it may be located in the same manner as the screw. (Fig. 171)

The other method of securing the legs is shown in Fig. 171. Screw fastenings of this sort may be used in many places. Fig.

172 is a drawing showing how the leg and screw would appear if cut through vertically at the center of the screw. Drawings of this nature are called sectional drawings or sections. Fig. 173 shows the leg with the hole bored, the screw and the hollow pin which is driven over the screw.

Fig. 170 shows them in place and the leg ready to be driven down tight to the top. It is often easier to force the dowels into place by clamping instead of driving. If but one dowel is used in each leg it may be located in the same manner as the screw. (Fig. 171)

The other method of securing the legs is shown in Fig. 171. Screw fastenings of this sort may be used in many places. Fig.

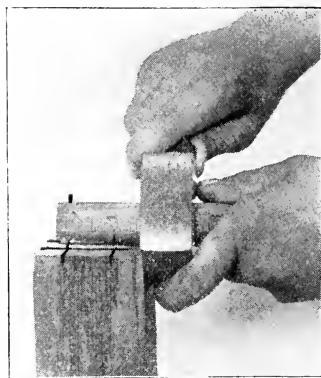


Fig. 168—Setting Gauge

After the end of the leg has been squared the center is located and a hole is bored large enough to receive the head of the screw and just deep enough to allow the head to rest on the bottom of the hole. It is essential that the hole be of the required depth.

A piece of metal as thick as will enter the slot in the screw head is then driven into the bottom of the hole. This is shown

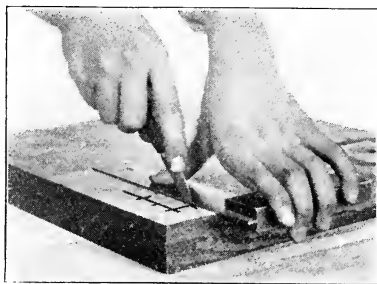


Fig. 169—Lining for Dowel

in Fig. 172. It may be driven to place by setting a screw

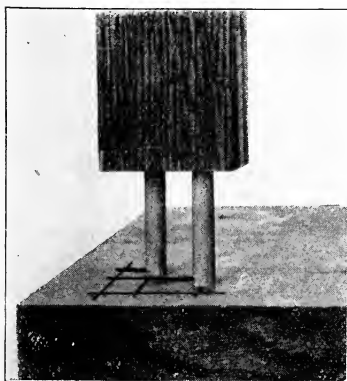


Fig. 170 - Inserting Dowels

over it and driving on the point of the screw. This piece of metal is to keep the screw from turning in the leg as the leg is screwed to the top.

The hollow pin must be glued in place. Place glue on the sides of the hole and also on the pin. Place the screw in position, being certain that the slot in the screw head fits over the piece of metal. Drive the hollow pin down firmly to the head of the screw, using a block with a hole in it to admit the projecting part of the screw.

After the glue has dried, the legs may be screwed to the top. Bore holes for the screws and use grease or soap in them. The

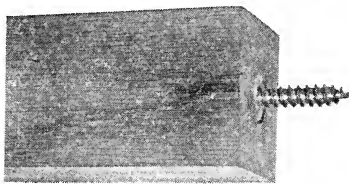


Fig. 171—Screw in End of Leg

Fig. 172—Section Through Screw, Pin and Leg

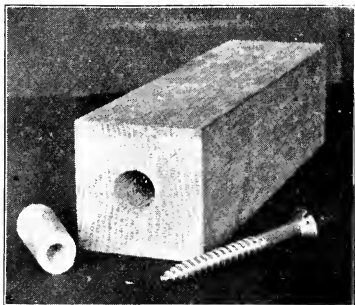
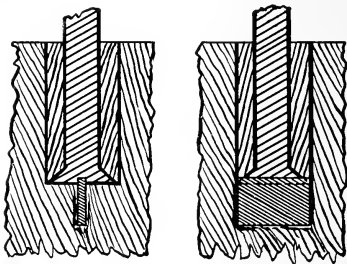


Fig. 173—Parts Ready to be Put Together

positions for holes are located by measuring from the edges or by drawing diagonals and measuring from each corner.

This footstool may be made with a soft wood top covered with leather.

LESSON 36

SCRAPING

It is seldom that the surface of hardwood can be properly sandpapered directly following the hand planing.

Fig. 174 illustrates a common cabinet scraper. It is not a difficult tool to use when once you have seen some one use it properly, but it is very hard to keep in order. It may be held as shown in Figs. 175 and 176 and pulled towards you, cutting a very fine shaving.

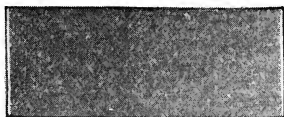


Fig. 174—Cabinet Scraper

Sometimes it is moved in the opposite direction as shown

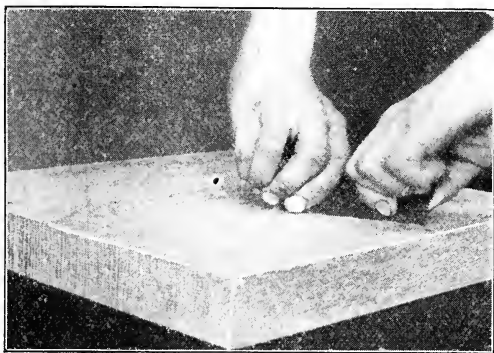


Fig. 175—Using Scraper, Pulling

in Figs. 177 and 178, but for your work and small hands, you had better pull it toward you and if it is necessary to work in the opposite direction, you should usually

either change your position or the position of the piece. You can change the angle at which it is held in order to avoid its "chattering" or making small irregularities in the surface.

Notice that the angle it makes with the surface of the board is the same in all the pictures. This angle should not vary and should be as nearly a right angle as will allow the scraper to cut.

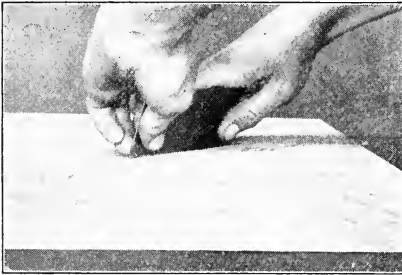


Fig. 176—Using Scraper, Pulling

The more firmly you hold the scraper, at the proper angle, the better it will cut and the longer it will keep sharp.

It should cut a fine shaving without tearing the surface on any hard wood, whether moved with the grain,

as in planing or against the grain. It is because it cuts smoothly against the grain that it is so useful for woods which have grain in both directions. Only by using a tool which cuts smoothly against the grain can such woods be properly finished.

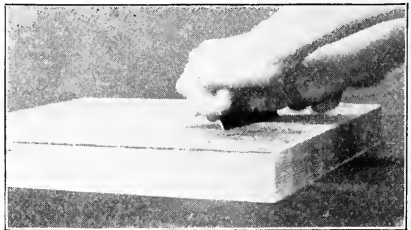


Fig. 177—Using Scraper, Pushing

In your use of the scraper, be careful to see exactly how and where it is cutting. Do not scrape more than is necessary. Some places will require no scraping; some spots of torn grain will require a great deal. Sometimes you will need to scrape places which are smooth, in order to make the entire surface level. A most important matter is

to avoid scraping the soft grain lower than the hard grain. Fig. 179 shows a surface with lines drawn to indicate the various positions of the scraper in finishing it. The lines are placed on different forms of grain and at different angles to indicate how the scraper should be placed and moved at these places. Lines which cross indicate that the scraper should be used at the two angles in succession. Sometimes the changes should be made at each stroke, but usually not so often. After surface has been properly scraped, sandpaper it as directed in Lesson 25.

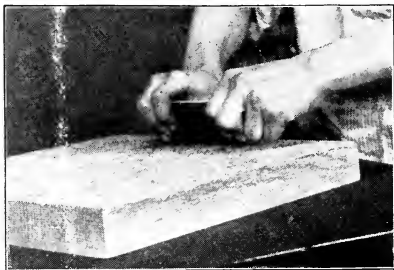


Fig. 178—Using Scraper, Pushing

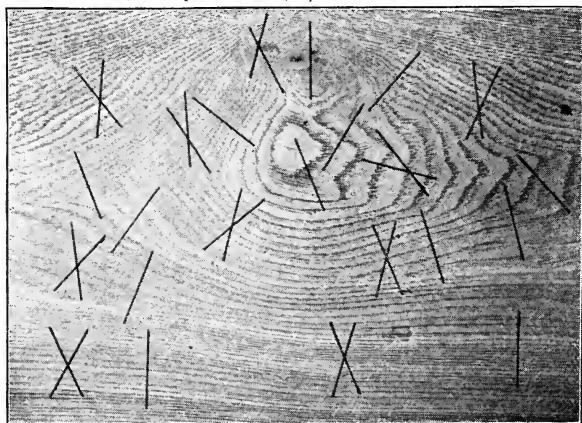


Fig. 179—Piece Lined to Show Method of Scraping

LESSON 37

TABORET

There are two results to be gained in the making of a taboret. The first and by far the most important is the *learning of something*, the second and far less important is the taboret. If you are to get the greatest good from the work, you must be careful about the design of the taboret. If you attempt to

make one which is too difficult, you will fail to learn what you ought, and also acquire habits which will hinder you in future.

The taboret illustrated in Fig. 180 is difficult enough for the first attempt. It requires no tools with which you are not familiar and you should make correctly every surface and joint.

It makes little difference which parts are made first. Usually you will succeed better by making first the top,

then the rails and last, the legs. Carefully study the drawing (Fig. 181) before beginning work.

The top is made the same as the cutting board, Fig. 117. Chamfering may be omitted.

The rails may be made in either of three ways. One way is to dress up a piece a *little more* than *four times* the length

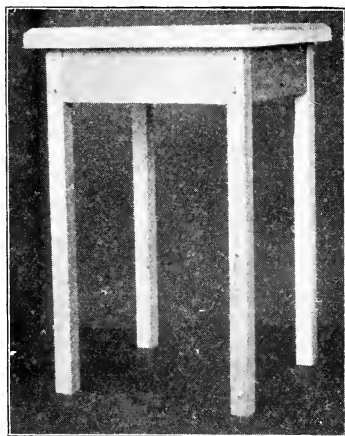


Fig. 180—Taboret

of one rail and as thick and wide as the rails are to be. The ends of this piece are then squared, to be sure that they are exactly correct as tested from both side and edge, as shown in Figs. 80 and 81. Unless you have a knife line to work to, the end will not make a good joint against the side of the leg. Be sure to follow all the directions given for end planing in Lesson 16.

After squaring the ends, two pieces of proper length for rails are cut off. The remainder of the piece is then worked in the same manner, making the other two rails.

Another way of making these four pieces is to take four pieces of stock, each large enough for one rail and dress them straight and square on all surfaces and edges. In order to make them all of the same length, you can hold them side by

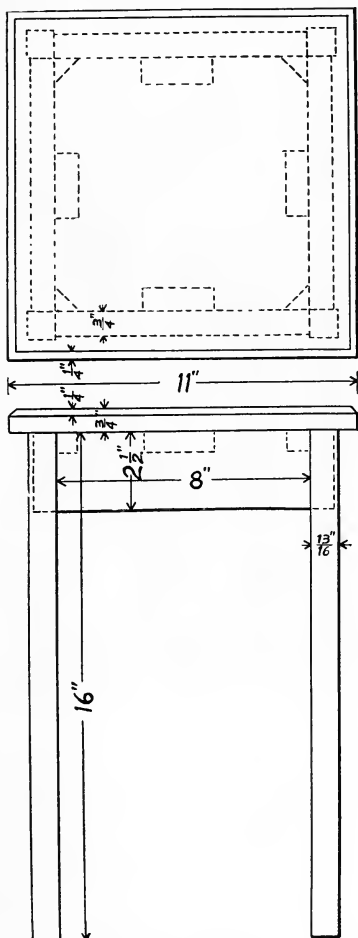


Fig. 181—Taboret

side, face-edge up, in the vise as shown in Fig. 182 and draw two lines across the edges, making the lines exactly the distance apart which you wish

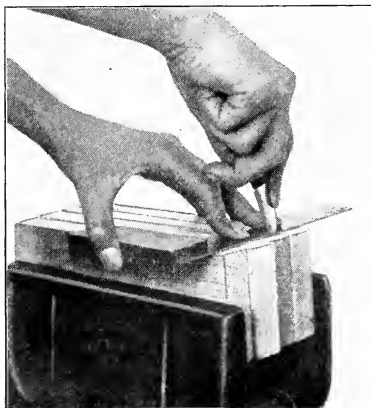


Fig. 182—Lining Ends

the length of the pieces to be. Plan, if you can, so that one line will be very close to one end, so that only the opposite end will require sawing. After the two lines are drawn upon the edges, remove the pieces from the vise and draw lines entirely around each end of each piece. Plane to these lines, sawing first if necessary. See Lesson 16.

A third way of making the rails is to dress a piece a *little more* than *four times* as wide as one rail, to allow waste in ripping. Finish the surfaces, edges and ends; then gauge for width. Rip apart the same as in making the legs

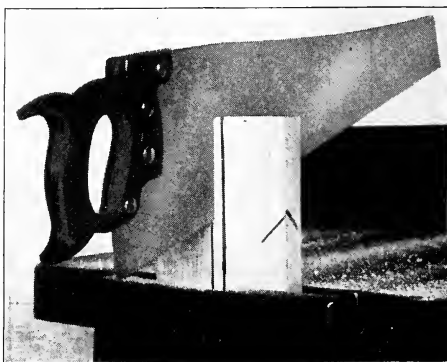


Fig. 183—Ripping Rails

(Figs. 184 and 185.) This is a good way to make all of the same length, but requires too wide stock.

To use pieces wide enough for two rails each is probably the best way of all. In order to do this, follow the same directions for jointing as in making the sides of the bench-hook. If the stock is so wide that there is some to rip off the width, make the piece as wide as it will work, and rip the waste from the center, (Fig. 183). By comparing Figs. 183, 184 and 185 you will see how to hold wide pieces in ripping. As the piece shown in Fig. 183 is short it can be held at the center of the vise and both kerfs made without moving it. The piece shown in Fig. 184 is so long that it must be



Fig. 184—Ripping Legs

held near the end of the vise jaw. This usually necessitates the moving of the piece to the other end of the jaw in ripping the piece off the other side. If the two pairs of rails vary in length a little it does no serious harm if they are used in pairs. That is, those of equal length opposite each other.

The legs may be made in the same manner as the rails. As they are longer and may be sprung or bent, you will need to be careful in planing them. They must be square, or the

joint at the side near the top end will not fit. In making the legs use a piece wide enough for all. Joint both ends and edges and rip a leg off each edge as shown in Figs. 184 and 185. Then re-joint the edges and rip off the other legs, leaving what waste there is at the center. (Fig. 183.)

In ripping pieces of this width they are all sawed from one



Fig. 185—Ripping Legs. Finishing

side unless they are quite thick. If they are very thick, or if you have not learned to saw, the piece may be reversed, as in Figs. 91 and 92 except that it is held in the vise as in Fig. 184. In order to saw at a sufficient angle to make the reversing of value, the handle of the saw must be held low. Fig. 185 shows how the piece is tipped as the saw nears the end.

After all the parts have been worked to the

proper sizes they should be sandpapered on all surfaces which are to be stained or finished. Ends and surfaces which form parts of the joints, the ends of the legs and the inside of the rails, should not be sandpapered. Only a strip near the edge of the bottom side of the top need be sandpapered. This affords an excellent opportunity to demonstrate that you know how to sandpaper, keeping all the surfaces and edges true.

LESSON 38

ASSEMBLING TABORET

After all the parts are ready to put together, set the legs on end in the position in which they will be when nailed in place, and mark an X at each side where a nail is to be driven into the side of a leg to secure the leg to the rail. These marks are not to give the exact location of the nails but to show you at what side and end the lines for locating the nails are to be drawn. Set the pencil end of the gauge to one half

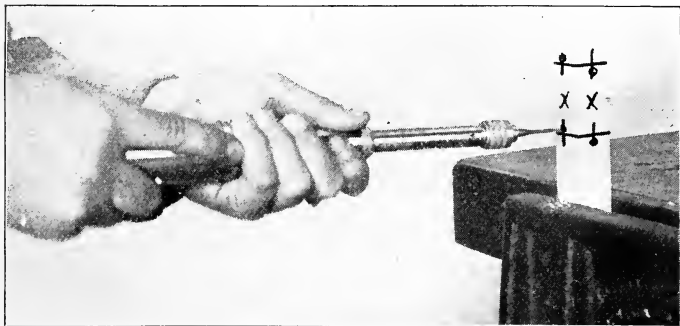


Fig. 186—Drilling Holes for Nails

the thickness of a rail, and draw a light pencil gauge line on each outside surface, (the surface opposite the face-marks) of each leg at the top end. You will notice that these lines are not on surfaces which have face-marks.

Lay the legs side by side with their top ends even and draw pencil lines to mark position of the nails. (Fig. 194) If you have made the rails of proper width, one line will be $\frac{1}{2}$

inch from the end, and the other 2 inches from the end. After removing the clamp, draw lines from the ends of these lines to locate the holes on the other side.

Place each leg in the vise and drill holes for the nails as



Fig. 187—Automatic Drill

shown in Fig. 186, using an automatic drill. If you drill each hole at the point

where the lines cross, the nails will meet each other in the piece, therefore drill the holes on one side a little above the lines, and the holes on the other side a little below the lines, as shown in the figure.

The automatic drill (Fig. 187) is worked by placing the drill point in position, and pressing endwise on the handle. Hold the handle at right angles to the surface so that the nails will enter the ends of the rails properly.

Start the nail the same as in nailing the benchhook, (Lesson 21) Hold the piece as shown in Fig. 188. Hold the face-side of the leg flush with the face-side of the rail and



Fig. 188—Nailing Together

the end of the leg flush with the face-edge of the rail. Drive the nail which is next the top, first driving it but a little, and then examine the piece, and, if it is all right, drive the other nail a little. Examine the piece again, and if correct, drive the nails in flush. Nail the leg to the opposite end of the rail in the same manner, except that before driving the second nail, the piece should be examined the same as in looking for wind. (Fig. 189)

Nail the second pair of legs in the same manner, and then nail the two pairs together. Test them carefully for wind, and when all are correct, set the nail-heads about $\frac{1}{32}$ inch, using a nailset, (Fig. 101)

Nail blocks into each corner as shown in Fig. 190. These blocks which are called

glue blocks may be made by dressing a square piece long enough for two blocks. The two opposite corners should be square and face-marked. After the piece is squared, it should be ripped in two, by ripping from corner to corner, or diagonally through the piece, (Fig. 191) Each half is then cut for two corner glue blocks.



Fig. 189—Looking for Wind

Often these blocks are used of rectangular section. Such blocks are but little stronger, and do not look as well. These blocks are not necessarily of any specified dimensions. If they are about the size shown in the drawing, (Fig. 181), they will fulfil their purpose. The angle which fits the corner must be exactly a right angle in order to hold the frame square. Drive several brads in each block. These brads

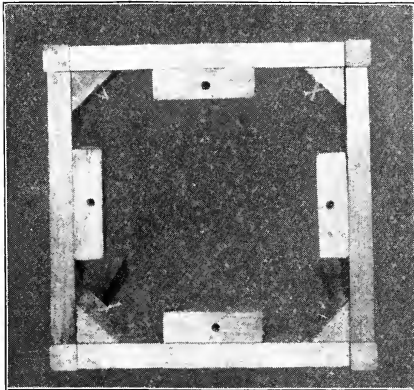


Fig. 190—Frame Showing Glue Blocks

may be of different lengths, the longer ones being used in the thicker part of the block. The brads should be driven only far enough to keep the blocks from slipping, and then the blocks should be removed and glue applied to the blocks and the surfaces of the rails. They should then be securely nailed in place.

Do not neglect to place a piece directly beneath the end into which the brads are being driven. You may find it necessary to put a clamp across the frame to hold the legs tightly against the ends of the rails while you are driving the nails.

After the triangular glue blocks at the corners are fastened, glue and nail four blocks midway between these, to use in securing the top. Before nailing the blocks in place, holes may be bored through each block. This will permit of screws

being used to hold the top in place. Read what is said about screws and their use.

When these blocks have been fastened, place the top on the bench, bottom side up, and place the frame in position. Measure at each corner from the side of the leg to the outer edge of the top and move the frame until all the measurements are equal, or as nearly so as is possible.

Put a screw in each of the four holes and start them by driving them a little with the hammer. Turn them in tight with a screw driver.

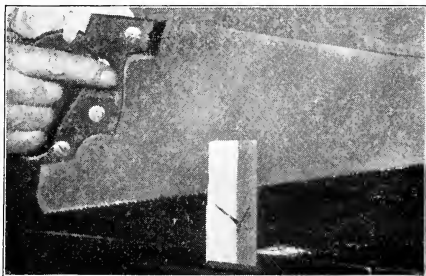


Fig. 191—Ripping Triangular Glue Blocks

If glue is placed on the sides of the legs and ends of the rails before the parts are nailed together, they will hold better. If the glue is placed on the ends of the rails first and allowed to soak in and then more glue applied and glue placed on the surfaces of the legs and allowed to dry a little before placing the parts together, they will hold still better.

LESSON 39

TABORET WITH SHELF

The taboret shown in Fig. 192 is made in the same manner as Fig. 181 up to the point of inserting the shelf. The shelf strengthens the frame, and makes the taboret stronger, therefore taborets may be larger if with shelves.

The shelf, (Fig. 193) consists of three pieces, one rectangular piece and two strips. The two strips are made first. They may be cut from a long strip or by



Fig. 192—Taboret with Shelf

ripping from the edge of a wide piece after the surface and ends have been trued. If they are made from a strip, the ends may be finished at an angle.

This will be found easier

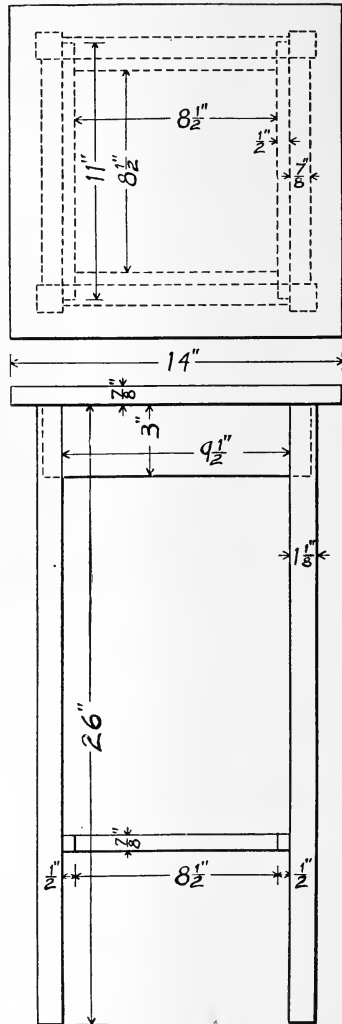


Fig. 193—Taboret

than making them square and will also give a better appearance. Before the legs are nailed in place, they should be clamped together, and pencil lines drawn locating positions of the nails for rails, and of the strips for the shelf. See Fig. 194.

The shelf is made in the same manner as the top. It should be square, that is, the length and width the same. Before cutting it to size, measure to see if the rails and strips



Fig. 194—Legs Clamped for Lining

are the same as the sizes given in the drawing. If they are not, make the shelf of a size that will hold the legs the same distance apart at top and bottom.

Nail and glue the strips in place, and, lastly, the shelf. Holes may, if necessary, be made for these nails with the drill, (Fig. 187). The shelf may be set flush with the side strips, or a little above or a little below them.

This style of construction gives sufficient strength for an ordinary center table 29 inches high.

LESSON 40

TABORET

Do not begin making this taboret (Fig. 195) until you have studied thoroughly the one described in Lesson 39; then make each part, following the drawing (Fig. 196).

The top, legs and rails are made in the same manner as the similar parts of Fig. 180.

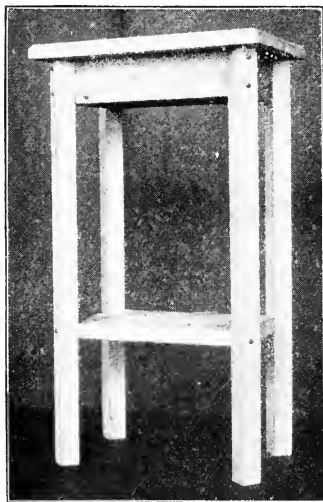


Fig. 195 -- Taboret

If the legs are made from small, square stock, they may be clamped together as shown in Fig. 194, lined very near their ends and then all placed in the vise at once and the ends planed as if they were one piece as shown in Fig. 197. The clamp must be kept on the legs during the lining and planing so that they may be worked as one piece. See Lesson 16.

The ends of the two rails are beveled in a manner similar to cutting the corners of the bread board. Hold them at an angle in the vise and plane at an angle similar to planing

ends, (Fig. 198). The rails are nailed together at their ends and a broad brace (Fig. 199) nailed across to keep the frame square. Glue blocks are then fitted to the corners.

The blocks may be clamped as in Fig. 199, or nailed. (Fig.

190.) If a clamp is used, it must not be tightened too much or it will pull the corner out of square. When the glue is dry, nails may be driven through the blocks into the rails. Be sure that the rails rest firmly on the bench, or the jar of nailing may break the joints.

Another method of joining the rails is to clamp the four rails together and bore two holes at each corner as shown in Fig. 200. Then fit dowel pins to the holes, and after applying glue to both pins and holes, drive the pins into place. Before driving the pins in, the glue should be dry enough so that it will not stick to the finger if lightly touched.

After the glue has dried, the corner angles

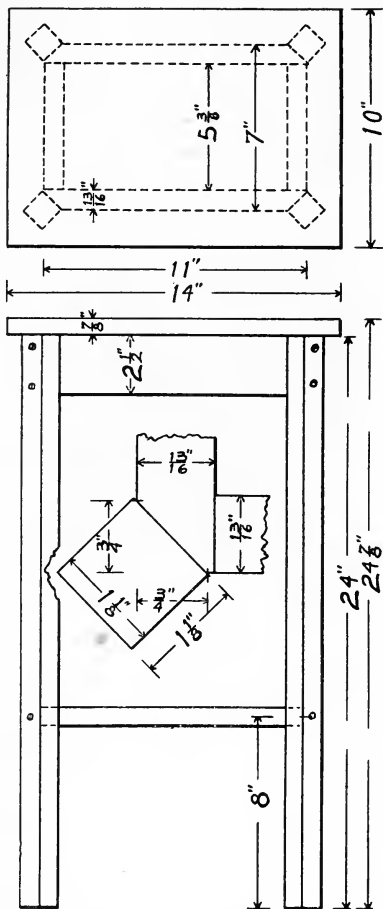


Fig. 196—Taboret

should be cut. As these angles determine the position of the legs, they should be very carefully lined and worked. To

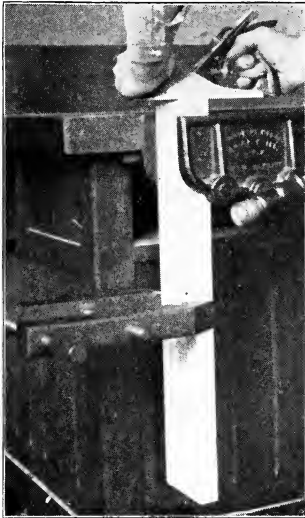


Fig. 197—Jointing Ends of Legs

plane them, hold them in the vise as shown in Fig. 201. While the glue is drying, make the shelf ready for cutting its corners. Instead of laying out the corners by the drawing, the rails may be clamped upon the shelf as in Fig. 202 and the corners marked. Be sure that both shelf and rails are right side up, and place a mark at one corner of each so that they may be returned to the same

relative position in nailing together. Trim the corners as directed for the bread board (Lesson 29).

It is easier to nail the legs if nail holes are drilled. To locate the holes, place the legs side by side, their top ends even, and draw a short pencil line on each leg to locate the nail hole. Drill the holes at the

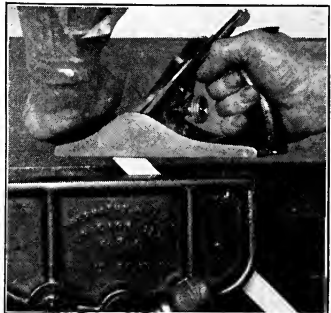


Fig. 198—Beveling Ends of Rails

center of the legs and then nail the parts together. As there are but two holes in each leg for securing the rails, *drill on the line*, not above or below as shown in Fig. 186. Examine the legs to see if they are square with the rails, and out of wind. Test the shelf also in several ways.

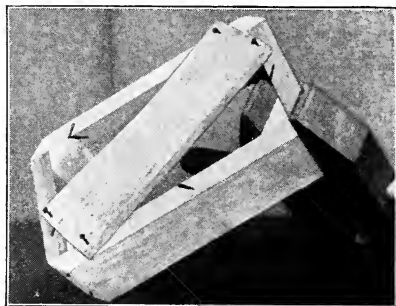


Fig. 199—Clamping Glue Block

The legs may be secured to the shelf by using round head blued screws. Such screws may also be used in securing the legs to the rails. If screws are to be used, bore holes in the legs large enough for the shanks of the screws.

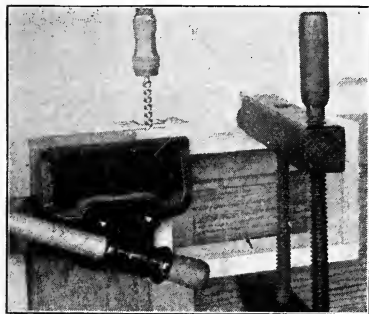


Fig. 200—Boring Holes in Corner

Bore holes in the shelf and rails about half the diameter of the screw thread. Put a little grease in these holes before starting the screws. Be very careful not to hit the nails as you bore the holes in the rails. If screws are to be used, plan for them as you nail the rails together and do not nail the glue blocks until after boring the holes for screws. It is best to use dowels at the corners if screws are to be used, and then you will not

spoil a bit in boring for the screws. In assembling the parts, first fasten the rails together, then the legs to the rails, next fasten the shelf and finish by putting on the top. See that all parts are straight, square and out of wind.

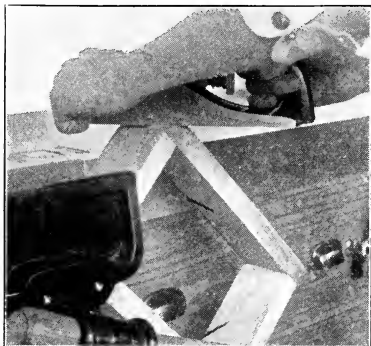


Fig. 201—Planing Corner

The size may vary from the smallest taboret to one the height of a dining-table. The amount which the top projects beyond the rails and the width of rails are features which are susceptible of changes to suit various needs.

The legs may not only vary in size, but in section, from square to extreme oblong, thus permitting the use of $\frac{7}{8}$ -inch material throughout. This will also permit of tapering or otherwise forming the outline of legs. The rails may be broad enough to hold the legs securely without the shelf.



Fig. 202—Rails and Shelf Clamped Together

LESSON 41

PEDESTAL

This pedestal, (Fig. 203) is a simple, plain problem; yet sufficiently difficult for any grade pupil. When made in oak or mahogany, it taxes the ability of a good first year high school boy. The necessity for true surfaces, edges and corners, is what makes it worth doing and if you are not good at planing, you had better use someother design.

It does not matter which part is made first, as all may be made from the drawing (Fig. 204). If the square column is begun first, other parts can be made while the glue joints of the column are drying.

In making the column, dress to a true surface what will be the inside of one side piece of the column. Fit to this surface the two pieces which will be the narrow side pieces of the column. Be sure to leave these pieces wide enough to allow for jointing and fitting to the other wide piece. Locate these pieces and drive nails at each end at the inside edges so that while being clamped, they will not slip. Drive the nails on an angle, with their heads extending beyond the ends of the sides, so that they can be readily removed after the glue is hard. Fig. 205 shows the parts in clamps,



Fig. 203—Pedestal

which are used also in gluing the other wide piece. To fit this second wide piece, true the joint side and then joint the edges of the narrow pieces. Plane these until they are of the proper width to give the correct size to the outside of the column. Should this piece be either thicker or thinner than the drawing calls for, plan the width of the narrow pieces, so that the outside of the column will be the correct size with very little planing after all sides are glued.

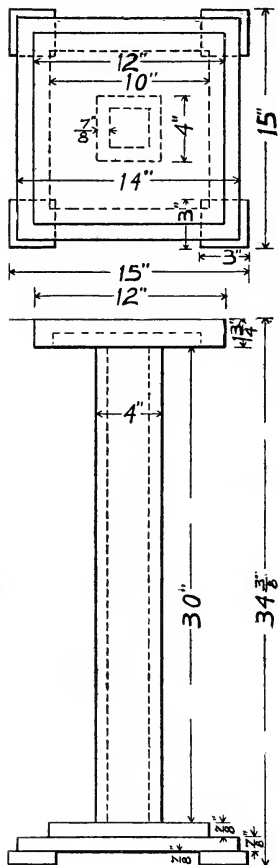


Fig. 204—Pedestal

Dress the outside of the column to the required size. Next square the ends. This you will find somewhat difficult but if you work carefully, watching and working to your lines you will succeed.

The main part of the top is planed on one surface and one edge and then cut to a size a little larger than the finished top. A narrow facing strip is then fitted and glued to the under surface of the top even with the straight edge, (Fig. 206).

The two end facings are next fitted. These are cut so that the grain will be parallel with the grain of the top. They are clamped as shown in Fig. 207.

Nails driven at an angle at the ends and the pieces crowded against them, will help to make the end joints against the first strip tight.

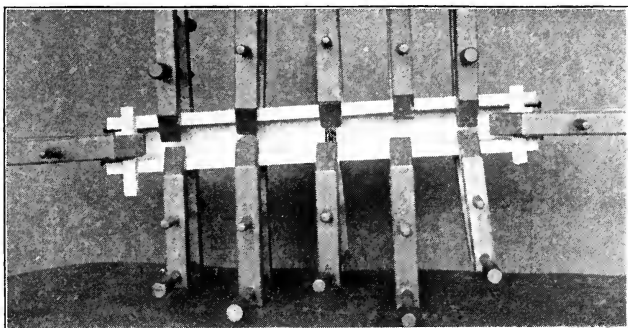


Fig. 205 - Clamping Column

The last facing strip is fitted and clamped as shown in Fig. 208.

After the parts have dried, the top is worked the same as a single thick piece.

The piece on the top end of the column may be of any size which will go between the facing strips of the top and

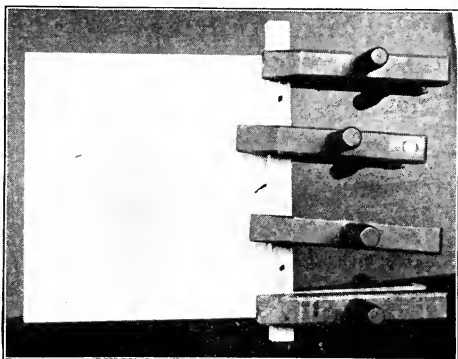


Fig. 206 - Facing Strip Clamped

receive the screws, therefore do not plane it except to make it of equal thickness throughout. There should be three or four screws through the piece into the top of the column and as many more up through the board into the pedestal top. In very cheap work, nails may be used instead of screws. Determine by careful measuring that the column is in the exact center of the top, before fastening it in place. If the top is of soft wood and the screws of proper size, the holes for the screws may be bored through the board, then the latter with

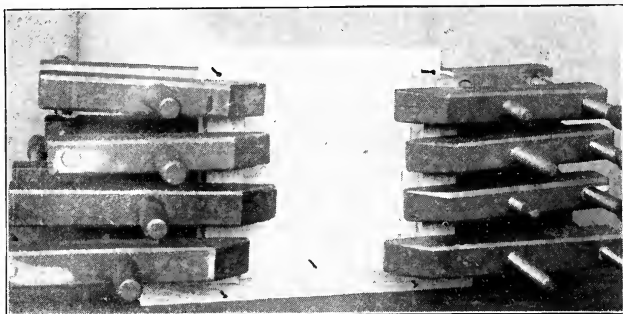


Fig. 207—End Facing Pieces Clamped

the column attached may be put in place. When the measurements show the column in the center of the top, screws may be driven part way into the top by using the hammer, and then the screw-driver used to finish forcing them to place. The base is fastened to the lower end of the column in a similar manner.

If the parts are of hard wood, the screws may be driven enough to mark the places and then the parts separated and

holes bored for the screws. The sub-base is fastened to the base as well as the feet to the sub-base with screws.

The design of the pedestal may be modified by making all

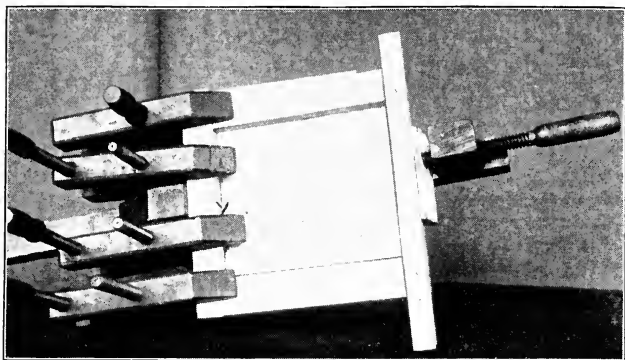


Fig. 208—Second Facing Strip Clamped

parts octagonal. If the column is to be made octagonal, it should be made from a solid piece. Chamfering may be used on the corners of the column if it is used on the edges of the top and bases.

LESSON 42

BOOK RACK

This rack may be varied in size to suit individual requirements. The board should be carefully trued on all surfaces. It may be chamfered on the upper edge, in which case it should be enough wider to allow for the chamfering.

The square pieces should be carefully jointed on all sides and all of each size should be made exactly alike and square in

cross section. After the pieces have been jointed and cut to length, the ends are rounded.

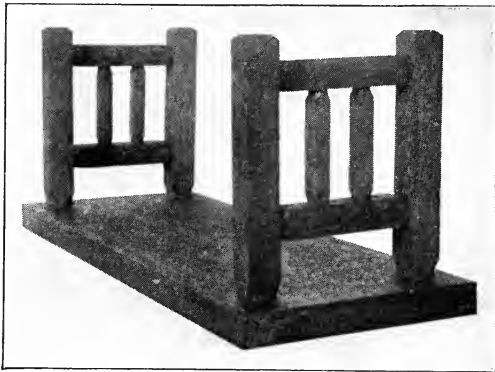


Fig. 209—Book Rack

and then cut off the corners, making it round. You will understand how this is done by reading the directions for making the cylinder, Lesson 67. It is not necessary to lay out the octagon, but you should understand how one is made and follow the same plan as nearly as you can without drawing the lines. The rounded part should be the same length and shape at each end so that in putting the pieces together, they will all

To do the rounding place a block in the vise and whittle the end as shown in Fig. 210. To make a nice end, first shape it like an octagon, (Fig. 211)

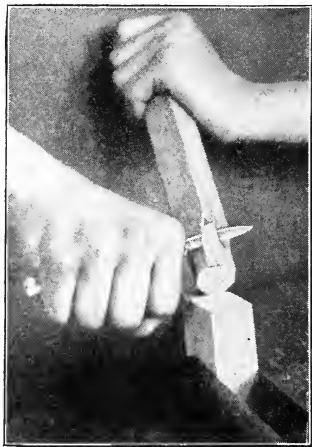


Fig. 210—Whittling on Block

enter the holes the same distance. Notice that the round part is of the same size for about 1 inch back from the end. This is very important if you wish to make a strong joint. If the whittled portion is tapered the entire length it will have so small a bearing in the hole that the glue will not hold. You may draw pencil lines at each end to assist in making them alike. Your success in shaping the ends depends largely on how you use your knife. Use the block as in Fig. 210 if you can. Sometimes you can whittle as in Fig. 212. Whittling past your thumb as shown

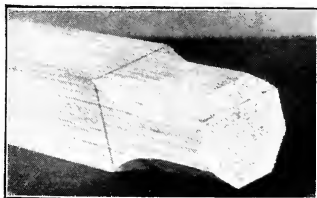


Fig. 211—Octagonal End



Fig. 212—Whittling End

in Fig. 213 is all right if you are particular to keep your thumb in such a position that the knife passes over and never against it; otherwise you are likely to have a cut thumb. This is no doubt a good way to whittle and is the *only way* for whittling many objects. It is not difficult to learn and should be learned by every one, (although the block should

be used for most of the whittling) being a method well adapted for removing the fine shavings, in finishing rather than for the



Fig. 213—Whittling End

These are merely typical positions for the knife. In working pieces of various sizes and shapes, the knife is held in many ways. Sometimes cutting toward the end and sometimes cutting in the opposite direction.

After the end is formed to an octagon in this manner, it is made sixteen sided and finally rounded, as was the cylinder, Fig. 304.

The two horizontal pieces of each end should be clamped

first heavy cuts. By comparing the different views you will notice that the knife is held at different angles and that different parts of the blade are used. By starting the shaving near the large end and gradually working toward the point, you will work faster and better.

The grain of the wood may require special care and the holding of the blade at a very oblique angle as shown in Fig. 214.



Fig. 214—Knife Blade at an Angle

together and the places for the spindle holes marked. Here you have an opportunity to exercise your judgment in spacing.

Bore the holes and make the small spindles and then sandpaper each before putting the parts together. Use the paper on your fingers for the straight sides of the pieces and on a round edged block, (Fig. 133), for the rounded ends.

The ends may be made separate from the base and not glued to it, so that in packing the ends will lie flat upon the base.

It is possible to hinge the ends the same as if they were solid boards, but the setting of the hinges is too difficult a task for most pupils at this time. Surface hinges should not be used for such a piece, and their use marks the work of a mere novice.

LESSON 43

REED FOOTSTOOL

The first thing in making this footstool (Fig. 215) is to set the pieces for the legs on end and select what are to be the outside surfaces. As the inside corners are the ones which determine the squareness of the frame, it is necessary to make these corners square and therefore the face-marks will be on the inside corners. As these



Fig. 215—Reed Footstool

will be less seen than the others, you will select the poorer faces for the face-sides, instead of the better faces as in work-

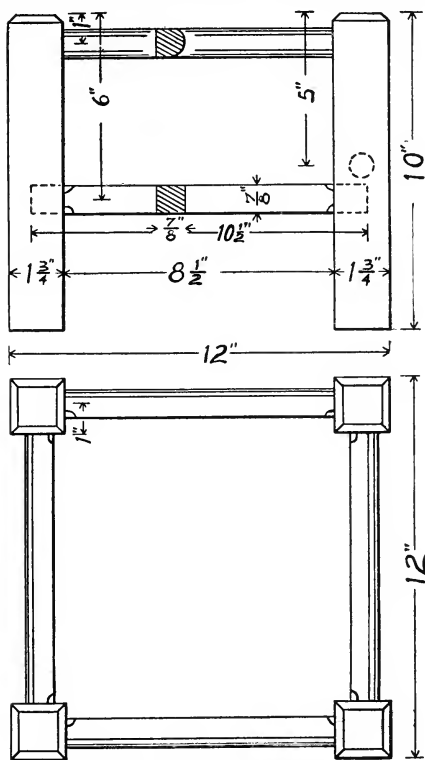


Fig. 216—Reed Footstool

ing the first piece (Lesson 4). That you may be sure to locate these marks in the proper place, stand the legs on end and mark an x on each side that is to be a face. After dressing the surfaces, use the face-marks as shown in Figs. 37 and 43.

After all four sides of each leg have been jointed, set them on end again and mark the places for the holes for the rungs (Fig. 217). From the drawing (Fig. 216) lay out one leg and then by superposition, lay out the others from this one. Be sure to make no

mistake. The chief difficulty is to locate the lower holes correctly as they are not alike on the two sides. At the same time

you mark the positions for the holes, you should mark points at which to draw knife lines for cutting off the ends and pencil lines for the chamfers. This is shown in Fig. 218. After longitudinal positions for the holes have been located, set the gauge and draw short lines across the knife lines to locate the lateral positions. By referring to the drawing you will note that the gauge is to be set at the same space for all the holes and is to be held with the head against the face-sides.

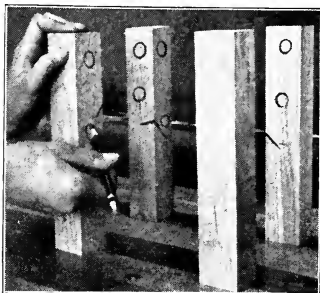


Fig. 217—Marking Position of Rungs

The boring of the holes is a matter of much importance, for if they are not at right angles to the surface, the footstool will not be square. One of the upper holes should be bored

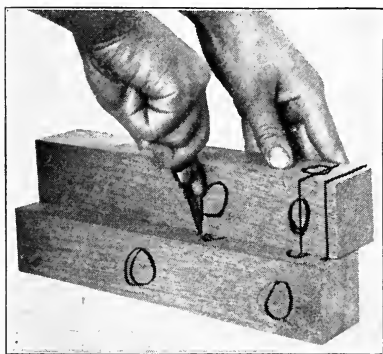


Fig. 218—Marking by Superposition

to a depth of about $1\frac{1}{4}$ inches and the other one bored until it meets this one. A better plan is to bore but one hole at the top of each leg until after the legs are glued in pairs. Then the other hole can be bored without so much danger of splitting the end. See Fig. 229. All the lower holes should be about

1½ inches deep. Chamfer the top ends, following the directions for chamfering, given in Lesson 18. As these chamfers

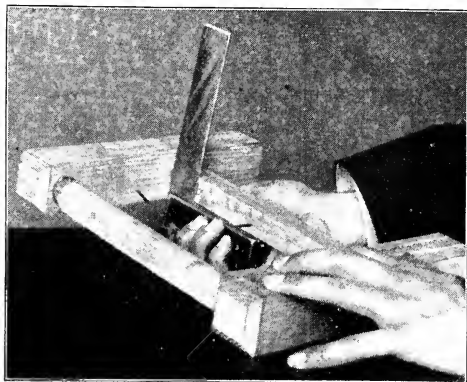


Fig. 219—Testing with Trysquare

are short you will be very careful to make them square, smooth and of equal size. Be particular to make them alike, and with sharp, clean cut edges, for if the chamfers are not well made, the appearance of the piece will be poor.

Select the four square pieces for the lower rungs; plane them to size and square; cut them to length and finish the ends as directed in Lesson 42.

The four remaining pieces are for the upper rungs. These should first be rounded at adjoining corners, following the directions for making the cylinder.

After they are rounded, whittle the

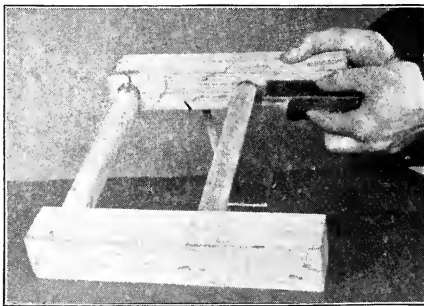


Fig. 220—Testing with Trysquare

ends the same as for the lower rungs. Dowel rod may be used for these pieces, but in using it you lose the opportunity of learning to do the rounding.

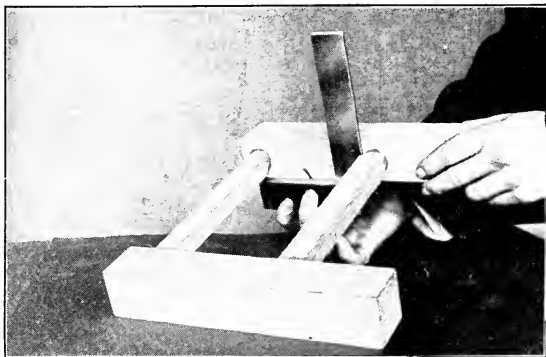


Fig. 221—Testing with Trysquare

After the parts have all been shaped and smoothed, select the rungs for the two opposite sides and put them together; if they are right, separate them and apply glue. Allow the glue to become nearly glazed and then force the pieces together by clamping. Be very careful to test your work at each stage by looking for wind (Fig. 189). Apply the try-

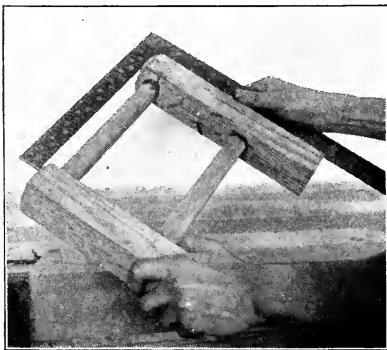


Fig. 222—Testing with Framing Square

square as in Figs. 219, 220 and 221. The framing square may be applied as in Fig. 222. You may be able to press the parts

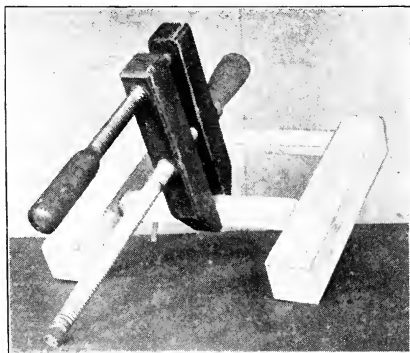


Fig. 223—Turning Rung

together without using any clamps but do not try to drive them together. By referring to Fig. 229 you will learn how a clamp may be used.

If the rungs require turning to make them square as tested in Fig. 221 a hand screw may be used, Fig. 223. If one end enter too easily it may

be held back by placing a hand-screw as shown in Fig. 224.

After each pair of legs has been put together and the glue allowed to dry, glue the pairs together in a similar manner, testing them thoroughly. They may be tested for squareness by measuring from corner to corner. Fig. 225.

The next work is the finishing. Read the lesson on finishing and use such materials as you think best for this piece.

There are many ways

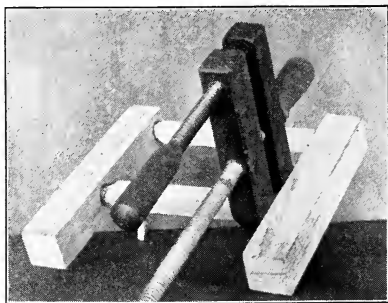


Fig. 224—Handscrew at End of Rung

of weaving the reed or other material used for the top of the footstool. The most simple is to wind the reed around one way and weave in the cross strands.

The weaving may be done by passing the strand first under and then over, making a simple regular pattern. By varying the num-

ber of strands passed over or under different patterns are made. To plan the weaving use small frame and weave string instead



Fig. 225—Testing by Measuring

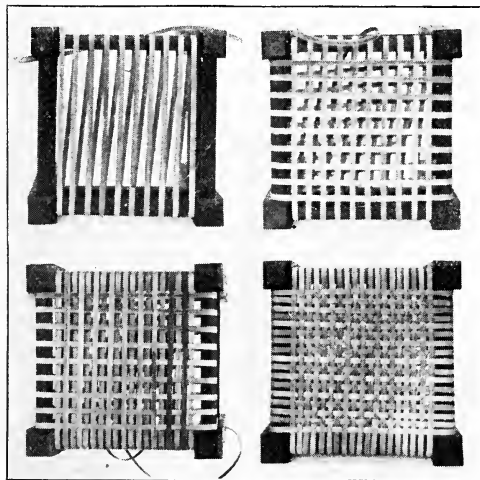


Fig. 226—Weaving

of the reeds. This will often save much time.

Another method of weaving and the best, if you will be careful to follow the directions, is to wind the reed around in three ways before doing any weaving. This is done in the manner shown in Fig. 226.

This shows a simple plain weave. By winding two or more strands close together or by leaving more than one space the pattern can be varied.

After the three windings the top is finished by stitching in the

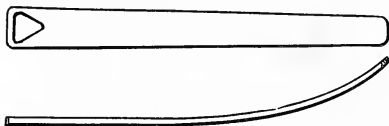


Fig. 227—Needle

last strands. For this a needle is required, such as is shown in Fig. 227.

It may be made from a piece of brass or iron and should be but little if any

wider than the reeds. Other materials may be used for the tops of such footstools, but reeds are probably most desirable for school use.

LESSON 44

TABORET.

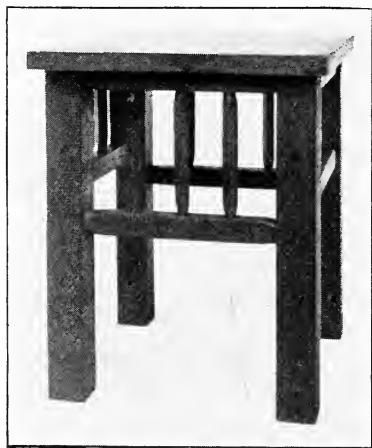


Fig. 228—Taboret

This taboret (Fig. 228) may be made of any ordinary size or proportion. Make a drawing giving the size of each part and the spacing.

If the top were covered with leather and the parts properly proportioned it would be a footstool.

In the taboret shown, the legs are $1\frac{3}{4}$ inches square and 14 inches high, the rungs $\frac{7}{8}$ inch square and the top 12 inches square. From these di-

mensions you can calculate the dimensions of the piece you wish to make.

Dress all the pieces straight and square. Plan to have the face-marks at the inside corners of the legs and at the upper and inside edges of the rungs or rails. In marking the places for boring and whittling the ends follow the directions given for making the book rack, (Lesson 42) and foot-stool (Lesson 43).

If but one hole is bored in the top of each leg before the sides are clamped there will be less danger of splitting the top ends. As the lower holes at the adjoining sides do not meet, they may

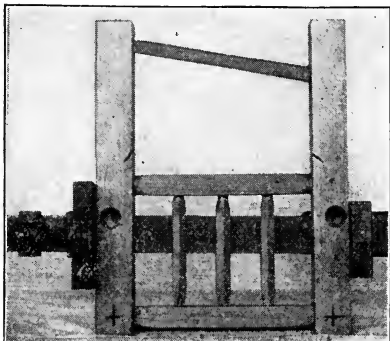


Fig. 229—Clamping Taboret

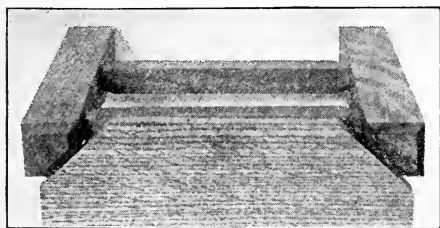


Fig. 230—Taboret Top

both be bored before clamping. It is usually necessary to force the parts together with clamps. Almost any light clamp or handscrew will answer, for the parts should fit so nicely that slight pressure is required. Should the ends not draw up alike a stick may be placed between them, Fig. 229. Read the directions for testing Fig. 215 before attempting to

put this taboret together. The top is fastened to the frame by boring holes down through the rails and inserting screws from beneath.

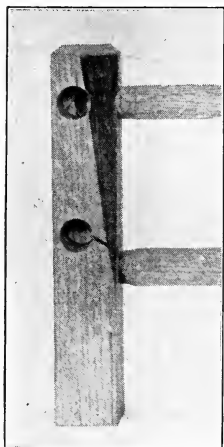


Fig. 231—Corner of Leg

A simple modification of this taboret is shown in Fig. 230. The general plan may be the same as Fig. 228. In order to allow for the extension of the legs above the top, they are dressed off at the inside corner and the top fitted by trimming the corners similar to making an octagon, or cutting the corners of the bread board, (Fig. 143).

When this construction is used the frame should first be made and then the top. Before beginning work, carefully draft out the top and legs so that you will be sure to have the parts well proportioned. Fig. 231 is a picture of the leg showing the flattened corner. This style of leg may be used on other than rectangular tops.

LESSON 45

BOOK RACK

This book or magazine rack, Fig. 232, may be any size from a rack of one shelf to a rack of four or five shelves, 3 feet long. It is best not to plan a rack requiring shelves more than 3 feet long, because the weight of the books will cause the shelves to spring or sag. Shelves 2 feet to $2\frac{1}{2}$ feet long are most desirable and satisfactory.

The sizes of the parts should vary to correspond with size

of rack. Posts $1\frac{3}{4}$ inches square are heavy enough for any rack and can be used on the smaller sizes. Posts $\frac{7}{8}$ inch square are suitable for racks of two shelves not over 2 feet long, but if such light posts are used, all the other parts must be correspondingly light. The shelves for such a light rack should not be over $\frac{1}{2}$ inch thick. Such light parts require very careful workmanship. If you are not sure that you can do very close work you ought not to attempt to make a light rack.

Before making your drawing look over the similar designs Figs. 209, 215, 228. The ends and back may be ornamented by either horizontal or vertical pieces as shown in these designs. Do not make the parts too fine or use too many pieces.



Fig. 232—Book Rack

All directions for making the rungs and laying out the parts are found in the directions for making Figs. 209, 215, 228. Follow these instructions carefully.

The shelves are made in the same manner as the base of the bench-hook, Fig. 74. In this design the shelves have much to do in holding the rack rigid and square, and should

therefore be carefully straightened and also be out of wind. Make the ends first, then glue the back pieces in place, and lastly fasten the shelves securely to the ends. The best way to secure the shelves is to bore holes up through the rails and insert screws.

LESSON 46

MAGAZINE RACK

The magazine rack shown in Fig. 233 is a very nice study in planing and nailing. The drawing (Fig. 234), gives the sizes of each part and if you work to these dimensions you will have little difficulty in completing the project.

The end pieces should be carefully trued on all sides, edges and ends, for if they are in wind, or the edges are not square,

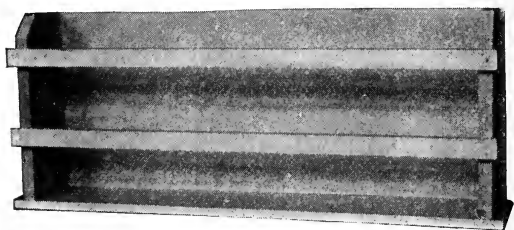


Fig. 233--Magazine Rack

the joints will not be good. Be particular to have your plane sharp while smoothing the end grain, for

one end should be carefully smoothed to form a joint, and the other end must be smooth, or it will not finish nicely.

The bottom should be straight on the edges and out of wind but need not be exactly straight on the sides. It should be of the same thickness throughout, but may be a little curved from end to end, for in putting together, the back will straighten

it. The back may also be curved a little, for the bottom will straighten it.

If the strips on the front are a little curved or sprung sideways, the convex side should be turned toward the inside or back.

Using thin pieces which are not perfectly straight may appear improper, but if you watch such pieces as you work them, you will discover that they are so easily sprung or straightened that it is useless to attempt to make them straight.

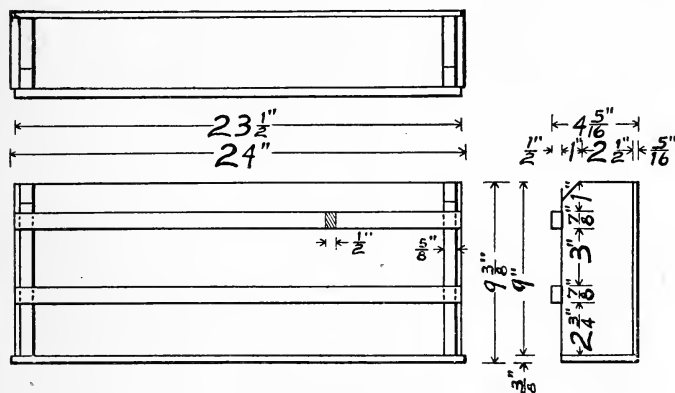


Fig. 234—Magazine Rack

If thin stock has been run through a good surface planer and is not in wind, usually all that is required is to go over each surface systematically with the smooth plane, joint the edges carefully and then force the piece straight sidewise in putting it in place.

The working of such thin lumber requires a much larger knowledge of planing and jointing than the working of thicker pieces. You should therefore thoroughly master the instruc-

tions in regard to the first study piece and make some pieces of thick stock before attempting any projects using thin material.

You should study Lessons 15, 20, 21, 24, 25 and 29, before attempting to make this rack, and you will receive far more benefit from this lesson if you make all of the objects in the lessons mentioned.

In assembling this piece, first nail the back to the ends and then the bottom and last the slats. With some kinds of finish all parts can be finished before nailing together.

Fancy headed nails may be used over the brads, or blued round head screws may be used in front and back.

LESSON 47

BOOK RACK

The size of a book rack is properly determined by the size and number of books it is to hold. The shelf should be

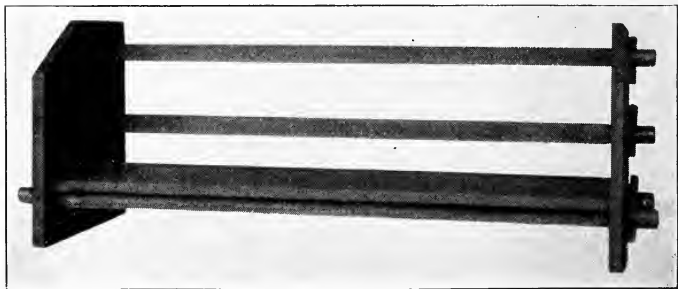


Fig. 235—Book Rack

smooth and straight and a little wider than the widest book. Carving or other roughness beneath books is objectionable.

Strips with spaces between or adjustable shelves made up of sliding strips should never be tolerated. The end supports should not be less than half the height of the book and usually three-quarters is more satisfactory. Sometimes it is desirable to make the end supports higher than the book. The back support when in combination with a level shelf need be only high enough to hinder the books being pushed beyond the edges of the shelf. In nearly all cases the back is not simply to hold the books, but to assist in holding the ends and other parts. When this is the purpose, other requirements must determine the size, strength and nature of the back; for anything which is sufficient to give strength to the case will, if properly placed, retain the books. The length of the shelf is determined by the number of books to be held until a limit is reached and then the shelves are increased in number rather than in length.

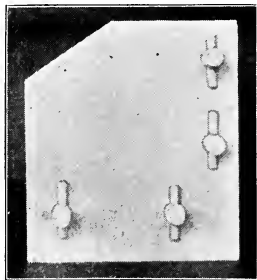


Fig. 236—End of Book Rack

Do not make the shelves too light. Books are heavy and will spring a shelf unless it is strong. For small books a shelf may be made 2 feet long of $\frac{1}{2}$ -inch stock. If the books are 8vo. the shelf should be $\frac{3}{4}$ inch thick.

By examining Fig. 135 and considering the above suggestions, you ought to be able to plan a rack for your own use. Do all the planning before you begin work, so that while making the piece you will have nothing to think about besides the study in construction. Be particular to review all directions for planing. (Lessons 4 to 11), sawing, (Lesson 14), cham-

fering, (Lesson 17), whittling, (Lesson 42) and sandpapering, (Lesson 25).

Do not attempt to make your Book-Rack until you have made the first study piece and done some chamfering and boring on a simpler project.

The end view, Fig. 236, shows the rails projecting through the end piece. Round pins are used to hold the rails in place. These pins may be flattened on one side. In this case the holes are bored so that a part of each hole is covered by the end piece. To insure the holes being in the center of the rods or rails they should be bored before the ends are rounded.

LESSON 48

PLATE RACK

This rack (Fig. 237), is made in substantially the same manner as Fig. 235.

The blocks (Fig. 238) for fastening to the wall should be

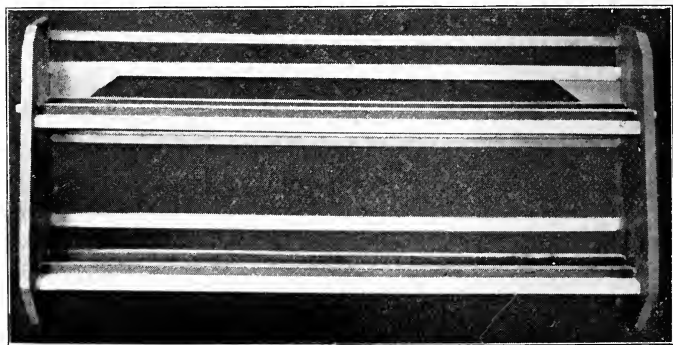


Fig. 237—Plate Rack

securely glued and screwed to the end and cross-rod and to the shelf so that there will be no possibility of their becoming

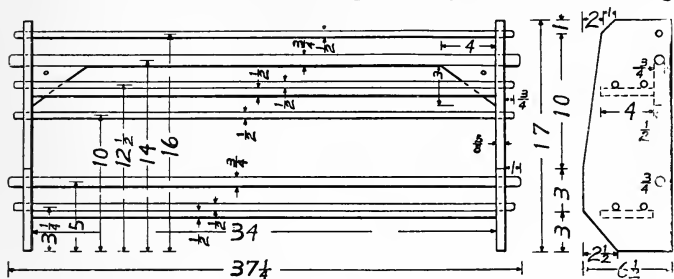


Fig. 238—Plate Rack

loosened. The holes in these blocks should be either 16 inches, 32 inches or 48 inches from center to center.

All the cross-rod may extend entirely through the ends as in Fig. 235, or some or all may be in blind holes as the rails of the book rack, (Fig. 232). Fig. 239 is an end view of Fig. 237. This shows a combination of rods with pins and rods with nails. Fig. 240 is a section through the end and rod showing the location of the nail. In Fig. 239 a nail is shown partly driven.

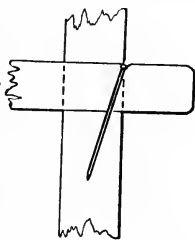


Fig. 240—Rods Nailed. Sectional View



Fig. 239—View of End

These nails should be very carefully driven so that they do not run out on the side of the end piece. A clamp should be used to hold

the pieces in place while the nails are being driven. Pins may be used instead of the nails, or the parts may be glued.

Unless the rods are of hard wood the shelves should be held by screws, either flat head or round head.

This plan of plate rack may be altered in many ways without materially increasing the difficulties of construction. The size and spacing of the rods should be determined to suit individual requirements. Hooks may be placed beneath the shelves as required.

LESSON 49

BOOK RACK

This book rack, Fig. 241, is of a type which may be modified to suit a great variety of needs. Made of a good cabinet



Fig. 241—Book Rack

wood it is a pleasing design as well as useful and a good lesson in woodwork. It is not a very difficult problem, and may be made by pupils who have learned to plane, bore, saw and drive nails.

The pieces for the troughs should be dressed on all four sides and then clamped together and lines drawn at each end at which to cut them off as in Fig. 194. In squaring these ends have good full lines entirely around

and then work exactly to the lines. Remember that it is much easier to draw the lines correctly, and saw close to them leaving only enough for smoothing with the plane, than it is to draw the lines carelessly, and then attempt to plane the ends square. Before doing any work on this rack, read all that is said about truing surfaces, jointing edges and squaring ends, in Lessons 1 to 20.

The posts should be made in the same manner as the legs for the taborets. Fig. 180 or Fig. 195. After the four legs have been dressed straight and square, calculate the amount of slant, and make the block to be used between the head of the try-square blade and the leg in lining around the ends, and in determining the angle at which the holes are to be bored.

On one leg in the drawing (Fig. 242) is shown a sketch of a try-square and a tapered piece. From the dimensions you learn that the ends are 7 inches wide at the

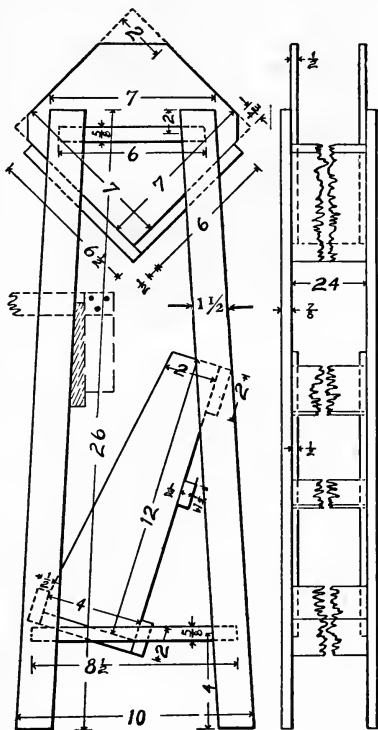


Fig. 242—Book Rack

top and 10 inches wide at the bottom. The slant height is 24 inches. This gives a slant of 3 inches in 24 inches of height, or 1 inch in width to each 8 inches of height. The slant is

equal on each side, therefore on one side the slant is $\frac{1}{2}$ inch to each 8 inches in height.

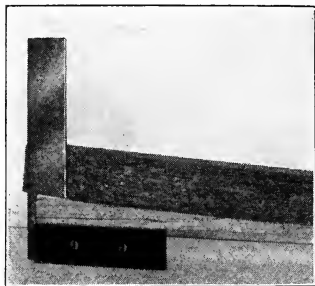


Fig. 243—Lining Across an End at an Angle

A piece 8 inches in slant length and $\frac{1}{2}$ inch wider at one end than at the other will exactly offset the slant of the legs. Such a piece placed between the head of the try-square and the leg will give all the angles for working the legs.

Fig. 243 shows how the piece

is placed for lining across the ends, Fig. 244 shows how the piece is used in boring the holes.

As a matter of convenience the piece is slotted at each end so it will slip over the try-square blade. Whether the wide or narrow end is over the blade is determined by the line to be drawn. Always place the head of the try-square or tapered piece against a face, the same as in ordinary work.

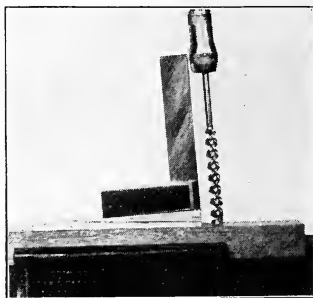


Fig. 244—Boring a Hole at an Angle

In laying out such work measure the lengths or spacing on the face-edge as the lines are straight across on the edge. Then from the ends of these lines

draw the slanting lines on the sides. In squaring the end for putting together it may be tested with the try-square and tapered block and also by measuring from the extreme outside corners. If it is not square it may be sprung to place and a brace nailed or clamped to it until the glue has dried. Another way is to clamp it to a board.

The design of the end may be changed considerably without requiring any additional directions. The upper cross-piece or rung answers the purpose of a handle. Square or round rods may be used lengthwise beneath the shelves to assist in keeping them in place. The strip at the front of the lower rack may be omitted. This permits making the end piece tapered the entire length at the front edge.

The pieces for the lower trough-ends may first be made in one piece similar to Fig. 163.

Some may prefer a pattern to use in laying out the pieces. Others may prefer to make one piece and mark the other from it. Whatever method is used draw knife lines to work to, and saw so near the lines that but little planing will be required.

Fasten the ends into the troughs first, and then fasten the legs to the trough ends. Glue and nails, dowels or screws may be used for holding the parts together.

This rack may be modified by changing the sizes of the parts, the angle of the shelves, or the number of shelves. The ends may be solid pieces instead of square or rectangular legs.

LESSON 50

PLANT STAND

This follows the same plan of work as the footstool (Fig. 215), and is practically the same excepting the extension of the legs above the top rail, the longer legs below, and the cross-rails which form the rest for the plant.



Fig. 245—Plant Stand

Read the directions for making round ends, Lesson 42 and for making the footstool (Fig. 215.)

As the legs are longer you should be more particular to make every part square and bore the holes correctly.

The hexagons or other ornamental pieces may be held in place by brads. To lay off the hexagon, set the compasses to one-half the space between the rods and strike a circle (Fig. 247). Notice that the compasses are held near the top. Draw the diameter A-B (Fig. 248) either with or across the grain. With the compasses set at the same space as in striking the circle place

one leg at the point A and mark the small arcs C and E, change the compasses to the point B and strike the arcs D and F. This should give the points or angles of the hexagon. Place the compasses on C and draw the other arc at D, and on E and

draw the other arc at F. If these last arcs cross the circle at exactly the same points as the first ones you can consider the points correctly located. Connect these points completing the hexagon. Draw knife lines to work to and saw and plane the hexagon to shape.

Various other geometrical forms may be used in this place.

First glue together the sides which receive the ends of the center cross-rails and then glue the two pairs of legs together.

The legs may be left square and straight, or may be tapered. In

articles of this sort which sustain considerable weight, the legs may be tapered on only the inside or face-sides, or on all sides. To work these tapers draw pencil lines across the face-

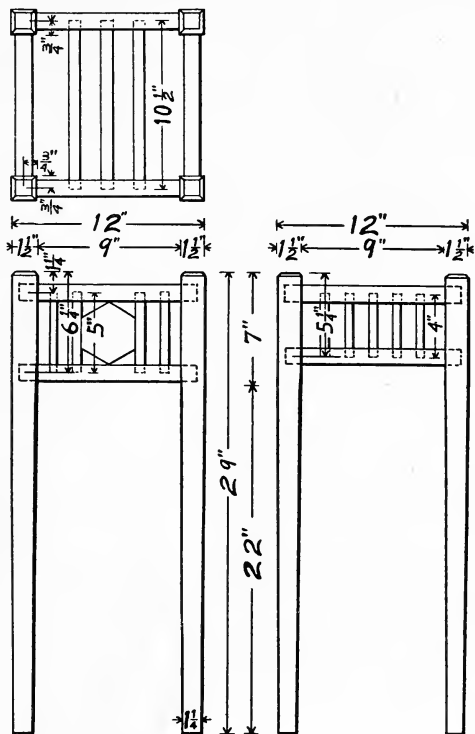


Fig. 246—Plant Stand

surfaces (Fig. 249A) for the end of the taper, and gauge lines on the lower ends, draw pencil lines lengthwise with a straight-edge connecting these points. If you are careful in planing these long lines may be omitted. Begin planing at a distance from the

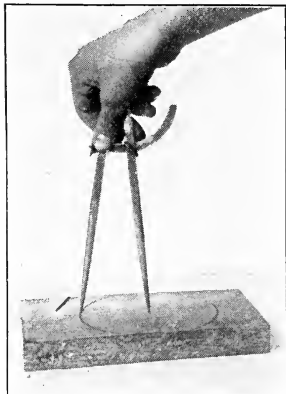


Fig. 247—Drawing Circle

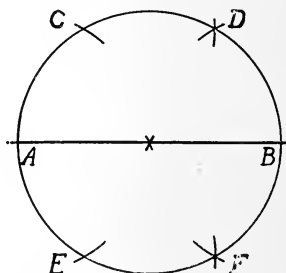


Fig. 248—Laying out Hexagon

pencil line which crosses the surface and gradually work back to it as you approach the gauge line on the end. In planing finish one surface before beginning another. After the two opposite surfaces have been tapered draw lines as in Fig. 249B and taper the other two surfaces.

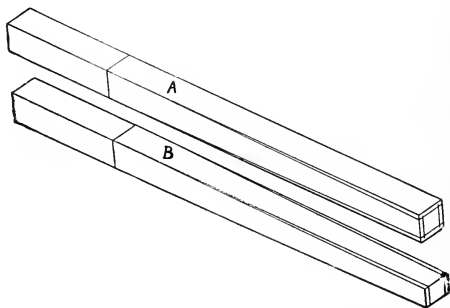


Fig. 249—Leg Lined for Tapering

This design offers an excellent

opportunity for the study of spacing and the use of simple geometric forms as part of the design.

LESSON 51

UMBRELLA RACK

This umbrella rack affords an opportunity for the use of exceptional ability in spacing. The size of the parts, distances between the horizontal pieces, and the variation in the number and length of parts in the different sections all afford an opportunity for good judgment as well as the use of the designer's art.

Do not use too many pieces. Fully determinè each part of the design before

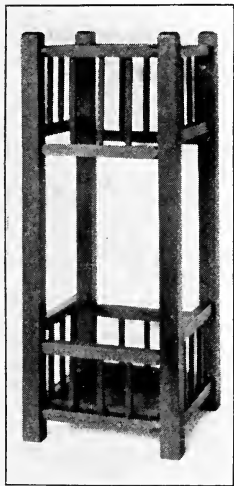


Fig. 250—Umbrella Rack

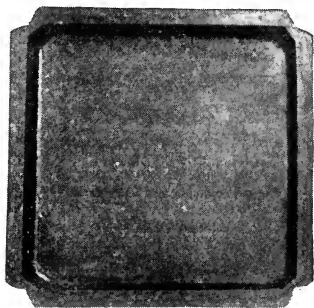


Fig. 251—Pan for Umbrella Rack

beginning work. In this rack the posts are $1\frac{1}{8}$ inches square, 25 inches high and $8\frac{3}{4}$ inches apart. The crossrails are $\frac{3}{4}$ inch square, $5\frac{1}{4}$ inches and $4\frac{1}{4}$ inches apart at the top and $4\frac{1}{4}$

inches and $3\frac{1}{4}$ inches apart at the bottom. The spindles are $\frac{3}{8}$ inch square. Make a complete drawing before beginning work.

Read the directions for making the book rack, Fig. 209; the footstool, Fig. 215; and the plant stand, Fig. 245.

The number of pieces in each side of this stand make necessary the careful fitting of all, or the rack will not be square when finished. You may find it necessary, in gluing, to clamp each side to a thick board in order to keep it square, and out of wind. Test your work in every way that you can and be sure that the glue on the sides is thoroughly dry before attempting to glue the two sides together.

The pan may be of copper or of cast iron as shown in Fig. 251.

LESSON 52

UMBRELLA RACK

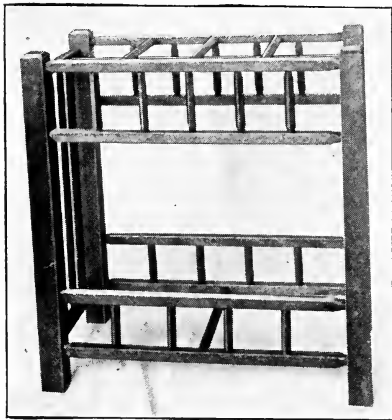


Fig. 252—Umbrella Rack

This is similar in construction to Fig. 250. There is an opportunity for a variety of spacing. This should be all planned and sketched before beginning work, for it may necessitate a change in the size of some part. As this rack is for several umbrellas, the material may all be larger than for Fig. 250. The height may be the

same. Read the directions for making, Figs. 245 and 250, before beginning the work.

From the illustration you can learn the method of dividing the top into rectangular spaces. The long central rail is placed either above or below the cross-rails so that no notching of one to the other is necessary.

Ordinarily, no fastening of these pieces is necessary, but if the cross-pieces appear to spring too much, they may be secured by using a screw from the under side at each place where parts cross.

There may be one pan extending the entire length of the rack, or there may be a pan for each division of the top. By using one short cross-rail at the bottom, as shown in Fig. 252, pans can be used for each four divisions. These may be planned so that the same pattern may be used as for Fig. 250.

The sizes of stock used in Fig. 252 are, posts, $1\frac{3}{4}$ inch square; rails, $\frac{3}{4}$ inch square; spindles, $\frac{1}{2}$ inch square; horizontal cross-rails for making the divisions, $\frac{5}{8}$ inch square.

LESSON 53

THREAD SCREEN

The center panel of this screen is 14 inches high and $7\frac{1}{4}$ inches wide. The side sections are 12 inches high and $6\frac{1}{4}$ inches wide. The stock is $\frac{5}{8}$ inch square for the uprights, $\frac{1}{2}$ inch square for the rails. The pins on which the spools turn are $\frac{3}{16}$ inch in diameter and about 2 inches long, including the part in the hole.

Lay out and work the pieces the same as for Figs. 209 and 215. Carefully read the directions for making these pieces before beginning to make the thread screen.

Plan the proportions and dimensions to suit your requirements. Make a complete drawing showing the size and location of each part

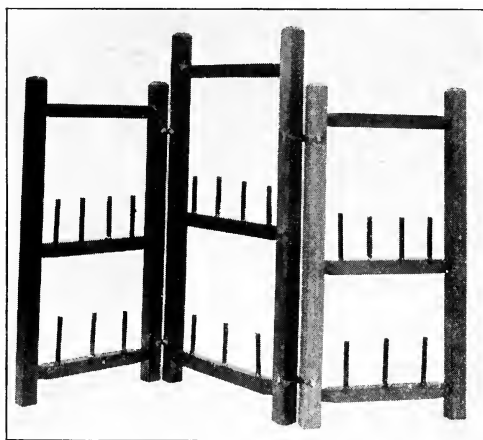


Fig. 253—Thread Screen

including the pins.

The parts are small and the holes not deep, therefore all the work must be well done or the screen will not stand well when completed. Bore the holes for the pins, but do not put them in before gluing

the sides and rails together.

To assist in squaring and also to keep the sides from coming too near together, pieces may be placed temporarily between the sides as shown in Fig. 254.

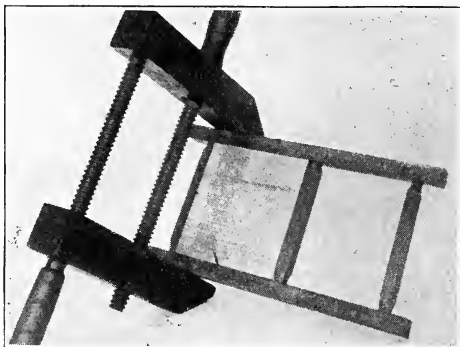


Fig. 254—Clamping Thread Screen

The hinges may be of leather the same as the screen (Fig. 259), or they may be made of cord as shown in detail in Fig. 255.

The cord is laced through one hole, then between the posts and through the second hole. This makes it double in the second hole. Pins are glued and forced into the holes to keep the cord from moving. No other fastening is required.

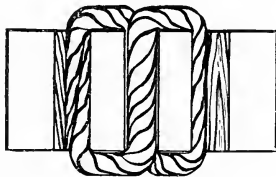


Fig. 255—Cord Hinge

Hinges hold such light pieces more rigid than the cord or leather fastenings. Fancy surface hinges may be used if you do not wish to make the screen so it will fold either way.

LESSON 54

SCREEN

This screen (Fig. 256) is a fine lesson in jointing, squaring, boring and designing, but it should not be undertaken until you have made some of the more simple objects of this class.

If you have had this experience, you require no additional directions except that as the material is light and long you will need to be very careful to bore all holes in the posts as deep as they can be bored without breaking through. You must keep ever in mind that the longer the parts the more any variation in the boring or whittling will show, and therefore be very careful to bore all holes exactly straight, and whittle all ends exactly alike.

Study all the designs of this class and make a drawing

showing the sizes of all the parts and the spacing. Instead of each panel being of a different height, the center panel may be the highest and the side panels of equal height. The

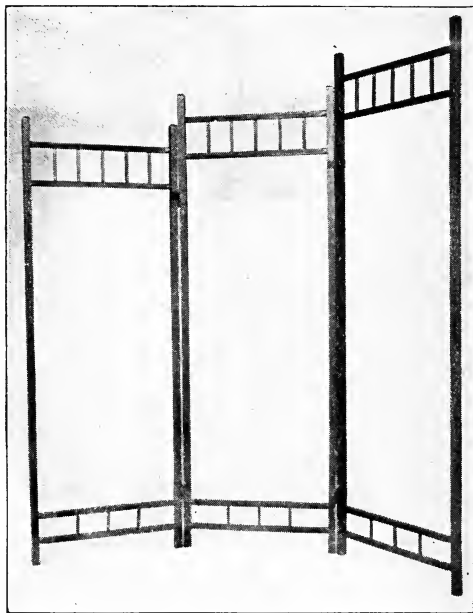


Fig. 256—Screen

drawing (Fig. 257) gives the dimensions of Fig. 256.

There are many ways of securing the tapestry, but for a light screen, the rods, as shown in Fig. 258, are probably

best. These are simply light curtain-rods. The leather hinge shown in detail in Fig. 259 is a very good hinge for a screen

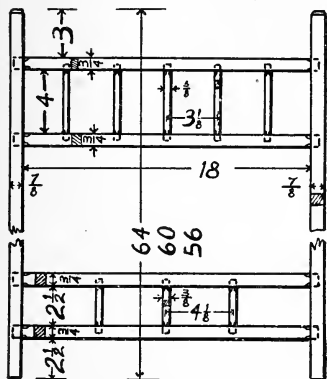


Fig. 257—Screen

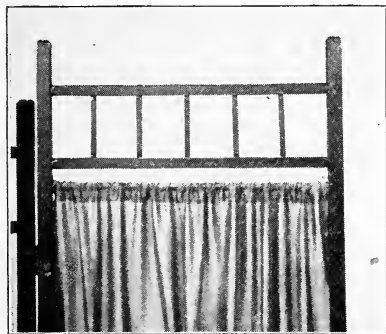


Fig. 258—Rods and Tapestry

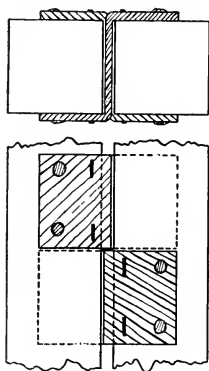


Fig. 259—Leather Hinge

of this size and weight, although other styles of hinges may be used.

LESSON 55

CHAIR

Do not attempt to make this chair until you have made some of the more simple projects in this class. If the work is well done, the chair will be serviceable, but if it is poorly made it will not be sufficiently strong. Carefully study the directions for making the book-rack (Fig. 209), the foot-stool (Fig. 215), and the screen (Fig. 256).



Fig. 260—Chair



Fig. 261—Chair Sides

More pieces may be used, or those shown may be differently placed. The sizes given in the drawing (Fig. 262) are as shown in Fig. 260.

The parts could be much heavier, but it will not be safe to make them lighter. By comparing the sizes given in the

drawing with the sizes of chairs in your home you may be able to plan a chair better suited to your needs. Make a complete

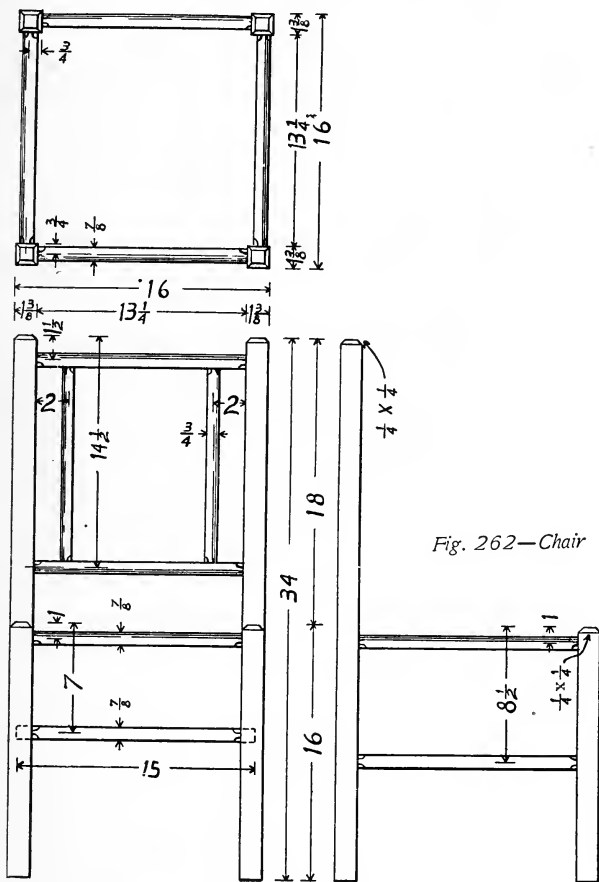


Fig. 262—Chair

drawing before beginning work. In putting the parts together assemble the sides first. To make both sides alike they may be clamped as shown in Fig. 261. After the two sides are finished insert the rungs and clamp them together. In all the assembling examine the pieces for wind. Test them with the try-square at each angle as shown in Lesson 43. Also use the framing square wherever the parts are large enough.

The back and seat are woven the same as the foot-stool seat (Lesson 43). Other styles of seating may be used. As there is considerable strain on the seat the upper inner edges of the rungs should be slightly rounded to avoid breaking the reeds.

LESSON 56

BLOTTER PAD

After you have learned to plane straight surfaces of ordinary length, you can study the planing of curves on short or thin pieces. You will find it more difficult to plane the pieces for the blotter pad than to plane such pieces as the study piece, the bench hook or bread board.

The drawing (Fig. 264) gives the sizes. Dress both pieces in the ordinary way making them both rectangular. It is much easier to do this than to plane the tapers and curve from a rough side.

To taper the top, first cut the piece to the finished length.

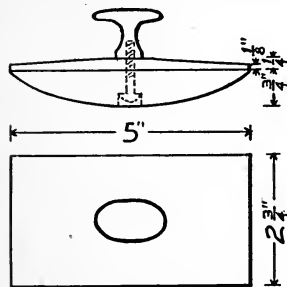


Fig. 264—Blotter Pad



Fig. 263—Blotter Pad

Draw pencil lines for the end of the taper near the center. Draw gauge lines for the thickness at the ends. (See Fig. 249.) Plane to these lines. Hold the piece against the stop in planing. Use a block between the stop and the piece to avoid bruising the end.

Draw a line on each edge for the curve of the thick or body piece of the pad. These lines may be

drawn free-hand or with the aid of a templet or pattern. They should be alike on each edge. As this curve cannot be planed

against the stop, you can place it in the vise as shown in Fig. 265. Part of the time the plane may be held at an angle of about 45 degrees and moved across from edge to edge, and part of the time the plane may be held parallel with the edges and moved along the curve. Test the surface from edge to edge with the try-square as in Fig. 25.

The parts are held together with a brass knob and screw, which may be secured from dealers in Manual Training Supplies. The sizes may be changed so that larger blotters can be used.



Fig. 265—Planing Curve

A very nice finish may be given the top and sides of this pad by applying several coats of white shellac and rubbing the surfaces down smooth after each coat. Usually for such porous woods the grain is filled before using the shellac, but for

so small a surface the entire finish may be made with white shellac. At first rub the finish with sandpaper, rubbing parallel with the grain and be careful to not rub too much at the edges. After you have applied sufficient shellac to cover the surface and fill the pores of the wood nearly even with the other parts, grind it all down to a thin even coating by using pumice stone and oil under a pad or wad of cloth or cotton waste. The last rubbing must be done with rotten stone or very fine pumice stone.

LESSON 57

SCOURING BOX

This box (Fig. 266), may be made of pine or of hard wood, and of a size to suit individual requirements. Fig. 268 gives the ordinary dimensions. The chief difficulty is



Fig. 266—Scouring Box



Fig. 267—Sides Ready for Ripping

the making of true surfaces and edges on material of this size and thickness.

Be careful to work each surface correctly as you proceed, following the same order as in working the first study piece, or the parts of the bench-hook.

The back is made in one piece, the ends planed as in Lesson 16 and the corners cut off as directed in Lesson 29.

To make the work easier, the sides are worked as one piece

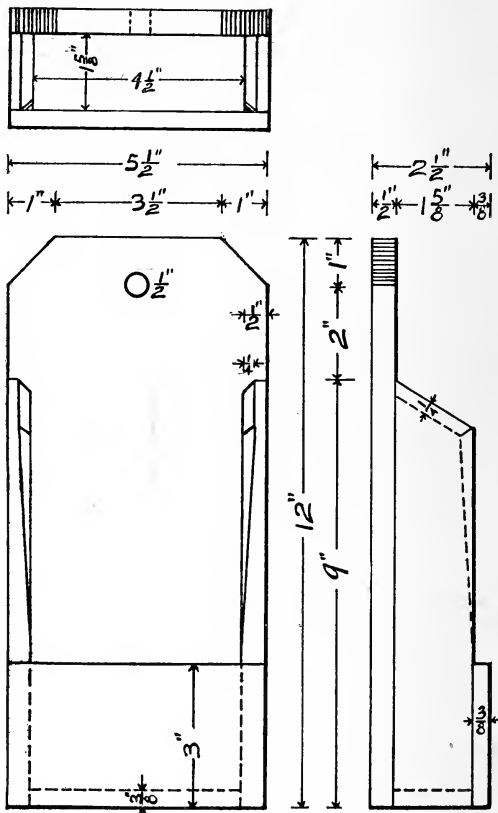


Fig. 268—Scouring Box

until all surfaces are true, the ends trimmed and the edges chamfered as shown in Fig. 267. The piece is then ripped in two, as in Figs. 184 and 185, and the other edges jointed.

The bottom and face-piece are then made. One piece is worked to a size wide enough or long enough for both face and bottom. After all sides and ends are finished the piece for the face is cut off and nailed in place.

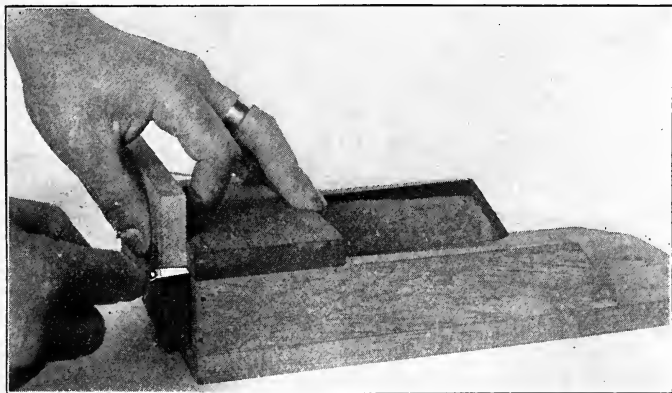


Fig. 269—Measuring Width of Bottom

The bottom is then fitted by marking the width as shown in Fig. 269 and sawing and planing to the marks. The length is marked as shown in Fig. 270. A line is drawn entirely around the piece and the end sawed and planed. It is then nailed in place. But little finish should be used on a box of this kind.

The shape of the back may be changed or it may be chamfered across the top and down the edges to the side pieces. Thinner stock may be used, but as the box is likely to be wet

when in use the thin lumber will not likely be satisfactory. To learn the reason for this, select two pieces of board of the same kind and quality of lumber, both of different thickness, and wet them on one side only. Lay them side by side to dry and watch the changes in their shape. Notice which one changes the most and see if you can find a reason for the

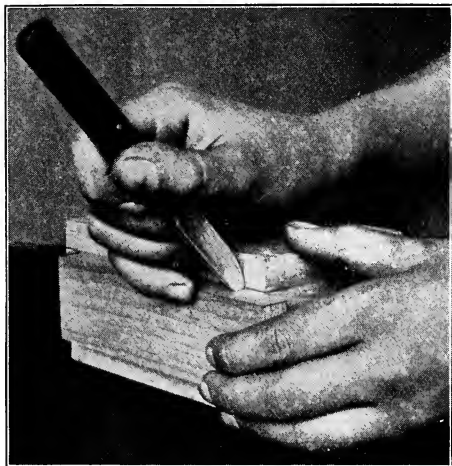


Fig. 270—Measuring Length of Bottom

difference. You may also experiment with different kinds of wood. Be particular to select specimens having the annual rings in similar position. You may notice a difference in the warping of two boards of the same kind of wood if one is cut at right angles to the rings and the other nearly parallel with them.

If at one time you leave a wide board lying flat on the bench top or floor and next time standing on end, or leaning against the bench, you will learn how boards may be warped or kept from warping.

The piece across the front may extend beyond the sides and have its ends rounded the same as the sides of the box, Fig. 287.

LESSON 58

WHISK BROOM HOLDER

The ease with which you make this will depend on how you work the parts. By observing the sizes given in Fig. 272 you will see that it may be made from one piece 20 inches long, 5 inches wide and $\frac{3}{8}$ inch thick.

Plane this as you did the study piece, Lesson 4, except that by going over each surface systematically the machine marks will be removed and the piece remain the same thickness throughout. The piece is so thin it can be bent or sprung, so do not attempt to make the surfaces perfectly straight. There should be no short irregularities in it, nor should it be in wind, and the edges must be square and straight. After truing the sides and edges, lay out the piece as shown in Fig. 273. One end should be lined and squared (Lesson 16). First cut off the corners and then the piece for the back and trim the edges, following directions for similar work (Lesson 29), and



Fig. 271—Whisk Broom Holder

square the lower end. Follow directions for nailing, Lesson 21, using 1-inch wire brads. The hole for suspending may be large enough to go over the head of a nail or screw, or only large enough for the shank so the broom holder will be held in place.

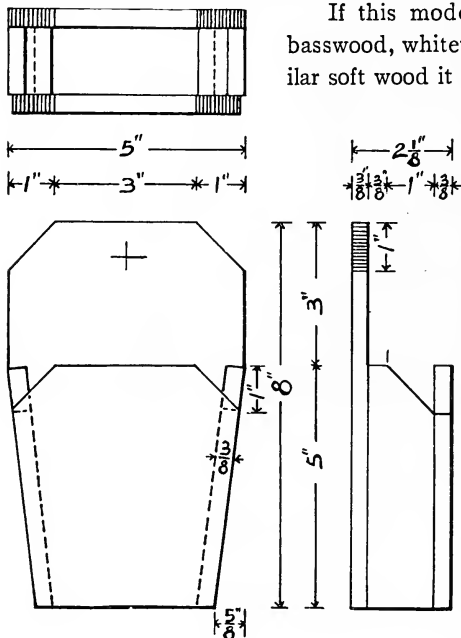


Fig. 272—Whisk Broom Holder

If this model is made of pine, basswood, whitewood, or some similar soft wood it is a very easy problem for one who

has learned to plane. To make the problem more difficult the shape of the back may be changed, also that of the front or of the sides. The corners may be chamfered or the front made wider and the edges extended past the sides and rounded the same as the ends of the box sides (Fig. 287).

Another modification and one which should be used by the more advanced pupils is to make the entire piece of some fine cabinet wood and polish it before fastening the front in place. This necessitates the front extending beyond the sides

and the use of fancy headed nails or escutcheon pins instead of brads in securing the front. Brads may be used to nail the back to the sides. In place of the brads or escutcheon pins, screws may be used. In using screws the parts should all be fastened together to see if all are correct, and then taken apart and the shellac or other finish applied.

Round head blued screws should be used in front and flat head screws at the back.

Escutcheon pins are a special form of nails with solid hemispherical heads. They are made of both brass and iron

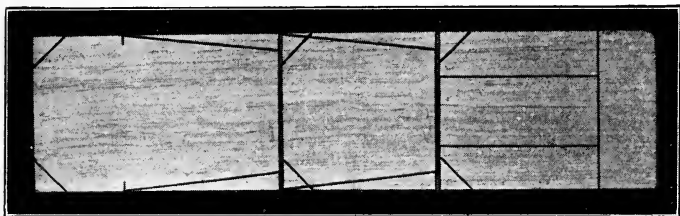


Fig. 273—Piece Laid Out

and in many sizes. If you use them in hard wood, holes should be drilled with the automatic drill (Fig. 187). Before polishing the holder put all the parts together, driving the nails through the front only enough to make certain that you will have no trouble in locating it properly, then remove the nails and apply the finish. The directions for polishing are found in Lesson 56.

In driving the nails after the surface has been polished be careful not to drive them too far or the finish will be cracked about the heads.

LESSON 59

MATCH STRIKE

While this is a "useful article" it is a waste of time to make it solely for use. Time is too precious to spend for such a purpose. If you have made the first study piece, the bench-hook, and the chamfered bread board, and yet feel that you

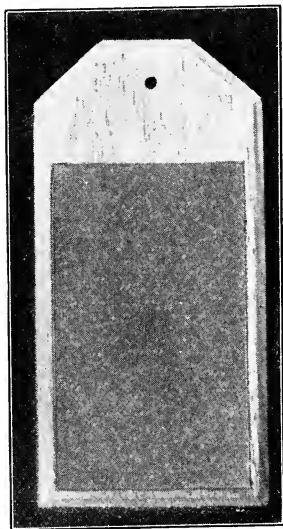


Fig. 274—Match Strike

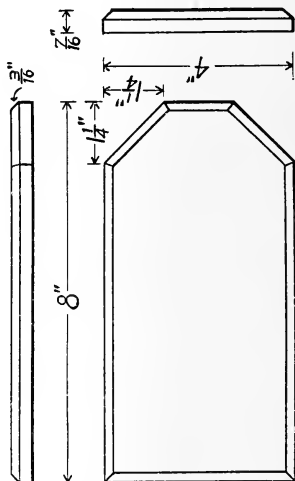


Fig. 275—Match Strike

do not understand planing and chamfering well enough to make, properly, one of the waste paper baskets, make this piece as a *study of planing*, but do not allow the thought of simply "making something" to influence you.

This lesson being a review of Lessons 13, 14, 18, 25 and 29, you should study these thoroughly as you proceed. Follow the drawing (Fig. 275) closely, or make a drawing for a different size and follow that. Be sure to leave all edges and corners straight and square, as in the drawing.

Smooth the surface for a first class finish and thus learn to do nice finishing. Do not mutilate it by line carving, stamping, or other "decoration."

LESSON 60

MATCH SAFE

To make the back of this match safe (Fig. 276) follow directions given for making the match strike (Fig. 274).

The octagonal receptacles are made in one piece, directions for making which are in Lesson 68. Each end is finished and bored, and then the piece cut in two. As the try-square head will not rest firmly against the octagon, a thin piece is held between the head of the try-square and the octagon (Fig. 277).

The parts are held together by nailing and gluing. Be sure that each part is thoroughly smoothed and sand-

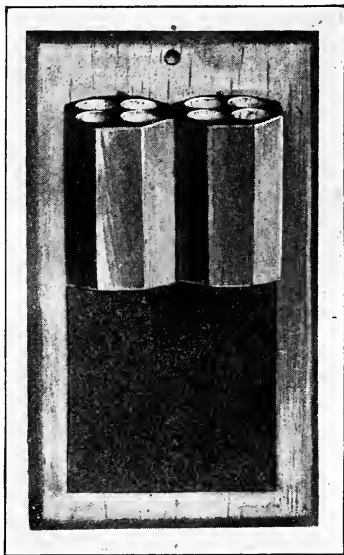


Fig. 276—Match Safe

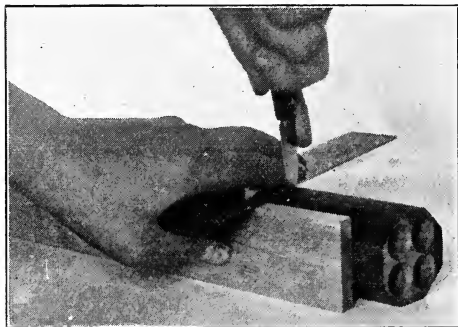


Fig. 277—Lining Around Octagon

every part is size of the drawing (Fig. 278) and every surface and edge straight and square you fail to correctly answer the problem though your piece may be usable.

The piece of sandpaper for the "strike" may be cut from a sheet of No. 1½ by laying the sheet, paper side up, on a cutting board and using a knife or it may be torn as shown in Fig. 121.

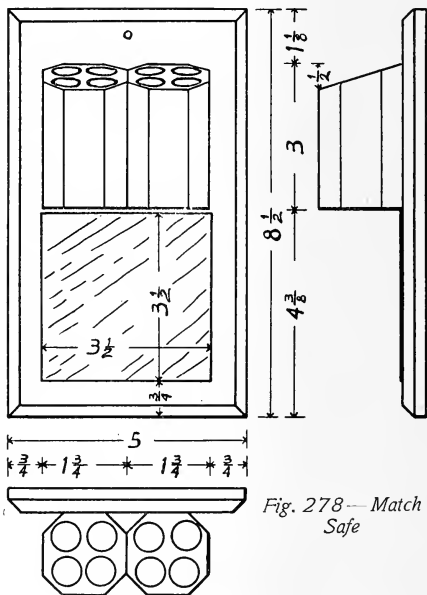


Fig. 278—Match Safe

papered before putting together.

Read the directions for sandpapering before doing this work, for the beauty of this piece is in perfectly finished surfaces and edges. Unless

LESSON 61

WASTE PAPER BASKET

The basket shown in Fig. 279 is 10 inches high and $9\frac{1}{2}$ inches across the bottom inside. A larger basket would be better for most purposes.

If no thin stock is at hand the sides may be made from $\frac{7}{8}$ -inch stock and split after the surfaces, edges and ends have been finished. In this work follow directions for working the first study piece except that as each piece is to be split you will place face-marks on both surfaces and have both surfaces true. Read Lesson 29 for directions for trimming the corners.

When ready to split the pieces draw lines entirely around the edges, placing the gauge first against one surface and then against the other. Set the gauge to the finished thickness of the pieces. Plan the thickness of the thick piece with just enough to waste in the center for sawing and smoothing with the plane.

If after the pieces have been smoothed on both sides you find that the face-marks, which should be at the inside, are on

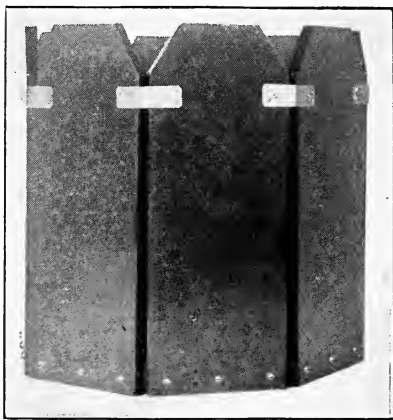


Fig. 279—Waste Paper Basket

the best surfaces, change the face-marks so that the nicer surfaces will be at the outside, and retest the edges.

To make the bottom, work the piece to an exact square of proper thickness and then lay off and work the corners. To find the point at which to draw the lines for cutting the corners draw diagonals and with the compass set to the space A-C (Fig. 280) draw the arc, C-B. Set the gauge (pencil) for the space B-E and draw lines on each edge (Fig. 146). Connect these lines on each surface with knife lines (Fig. 145)

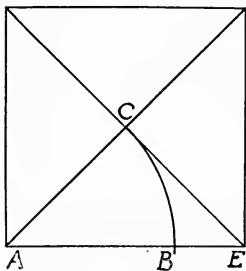


Fig. 280—Laying off Octagon

and saw and plane to these. Be careful to make each side of the octagon of correct length and square with the surface, so the side pieces of the basket will fit perfectly.

When the base is complete, place the side pieces in position and see if they are correct. If they are, locate the holes and bore them from the outer surface so that if the bit splits the surface the defect will be next the

base. Hold each side in place and mark through the holes for the holes in the base. Do not bore these holes too large.

If the sides are to be laced read directions for boring the holes, Lesson 62. After all the holes have been bored sandpaper all surfaces ready for the finish and then fasten the sides in place. For a cheap basket use nails instead of screws. No holes are required for nails in ordinary soft wood. Fancy nails may be used over long brads to improve the appearance, or long escutcheon pins with neat round heads.

The top ends may be held by lacing or suitable metal

fastenings. Plain pieces as shown in Fig. 279 may be cut from copper, brass or silver, or fancy pieces may be made in the metal shop. Fancy hinges may be used instead of bent pieces.

The finish may be applied before or after the parts are fastened together, or the piece may be assembled and then taken apart for finishing. The nature of the wood and the finish used must determine which method to follow.

LESSON 62

WASTE PAPER BASKET

Read all the directions for making Fig. 279 and you will have the information necessary for making the bottom and for getting out the sides except that required because the sides slant.

The drawing, (Fig. 282) gives you the amount of slant for each side, and also shows a try-square with a tapered piece between the head and the side piece or stave. Observe that the slant height of the side is 12 inches and the length of the try-square head about 5 inches. If the side slants 2 inches in



Fig. 281—Waste Paper Basket

12 inches it will slant just $\frac{1}{2}$ inch in 3 inches. Because of this relation you can plane a piece about 3 inches long and saw a slit in one or both ends to slip over the try-square blade as

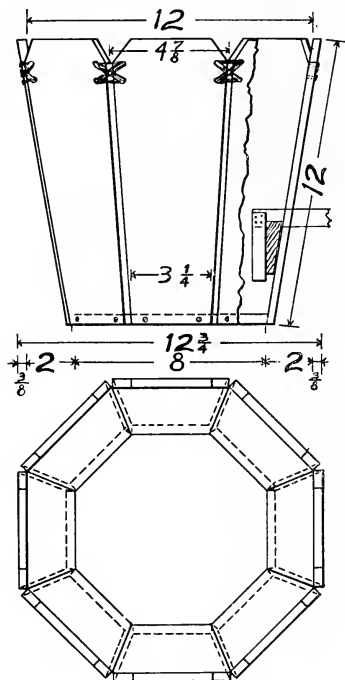


Fig. 282—Waste Paper Basket

shown in Fig. 243. You then measure off on the piece 3 inches and make the width $\frac{1}{2}$ inch wider at one line than at the other. It does not matter what the width is, but it must be $\frac{1}{2}$ inch wider at one line than at the other. If you wish to be very accurate in your work, you should measure the 3 inches on the slant height and slant length of the piece. You can do this by remeasuring the 3 inch space after the piece is tapered. It will probably be so slight a difference as to be immaterial. If the slant were great it would be necessary to take account of it. This will give the angle of the side and the try-square and block are then used similarly to a try-square on square work. If the piece has a saw kerf at each end it may be reversed, or two pieces may be used.

For this basket all the angles may be lined or tested with

one piece keeping it always in the same position. If you make the bottom first you can vary the width of the staves to correspond to the lengths of the sides of the bottom. The edges of the bottom should be worked at right-angles to the face-side and then beveled to fit the slanting sides. Fig. 283 shows how to hold the try-square and block.



Fig. 283 — Try-square on Edge of Base

Dress the pieces for the staves on both surfaces, both ends and one edge and then lay out by measurement from the drawing, or else make a pattern from which to lay out each piece.

Finish the corners and then bevel both top and bottom ends to correspond with the slant of the sides using the block and try-square at each end.

The sides may be fastened together at the top by lacing. There are several ways of lacing corners,



Fig. 284—Detail of Lacing

Fig. 284 shows one, the ends of the lace being fastened by driving a small brad at an angle through the lace and into the hole, so that the end is not seen.

Read Lesson 61 for directions for fastening the lower ends to the bottom.

LESSON 63

WORK BASKET

There are innumerable variations in this style of basket. It may be larger or smaller and various woods may be used. Some of the sides may extend below the bottom and thus form short legs. Similar sides may be secured around the edge of a table top, and may be vertical, though for most

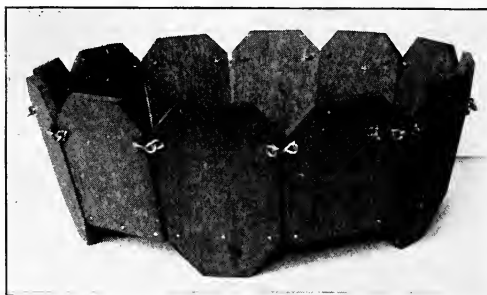


Fig. 285 - Work Basket

uses the oblique are better, making a light work table. Any form of taboret may be modified to suit this purpose, but such a table should have light legs and rails. In

making the work basket, follow the directions for making the waste paper basket, Fig. 279 or 281.

To lay out the dodecagon or 12-sided-bottom first lay off a hexagon, (Fig. 248). Bisect one of these divisions, (Fig. 286) and set the compasses to this space and mark the points for

the other divisions. Connect these points with straight lines completing the 12-sided-figure or dodecagon.

The fastenings shown in the picture at the upper ends of the staves were made from links of a jack-chain. Three links are required at each place. One extends across the space and one at each end of the three link fastening is straightened at one end and put through a hole drilled in the stave. After the straight end has passed through the hole it is so bent that it will remain in place.

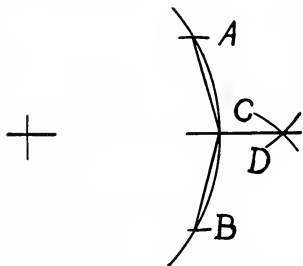


Fig. 286—Bisecting Side of Hexagon

LESSON 64

BOXES

The successful making of boxes depends very largely upon the truing of the ends of the pieces. If you have made a few

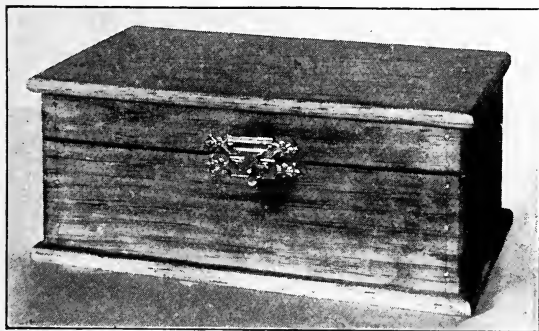


Fig. 287—Box

pieces having squared ends you will have no trouble in making a box with well fitted joints.

Fig. 287 is a typical

box and if you work carefully, studying each step, you should be able to make boxes of any size and style so long as the corners are square butt joints.

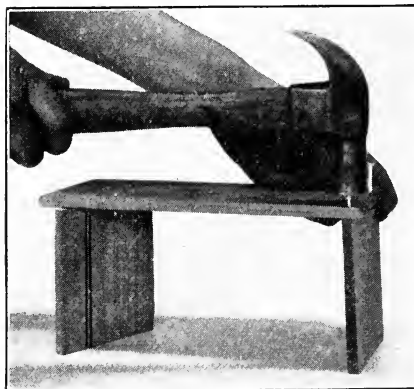


Fig. 288—Nailing End

For the top, bottom and sides follow the directions given for the cutting board, (Fig. 116). The ends of all the pieces are first made square. The end pieces are made in one piece, and after both ends are squared the piece is cut in two by measuring the proper

length from each end and cutting the waste from the center. See Fig. 314.

As the ends of these pieces are to form the joints they must be true. It is not enough that they are square as tested from side and edge (Lesson 16), but in order to make a good joint the edges should be as smooth and even as the lines of the knife point. Be sure this glossy edge extends entirely around each end. The



Fig. 289—Testing End

ends of all the parts may be left square. If any are to be rounded, read about rounding edges (Lesson 30). The edge of the bottom may be made oval, as in Fig. 287.

Before the sides and ends are nailed together, draw two gauge lines for use in sawing the box apart after the top and bottom are in place. These lines should be drawn entirely around both sides and ends

In locating these lines, allow $\frac{1}{8}$ inch to $\frac{3}{16}$ inch for saw kerf and planing, depending upon how well you can saw and plane. Select the brads

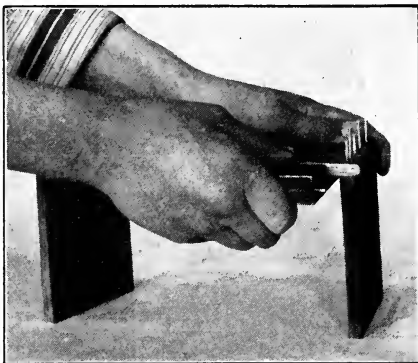


Fig. 290—Testing End

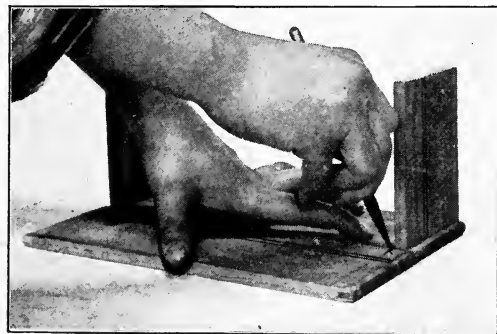


Fig. 291—Transferring Measurement

to be used in nailing the top, and be sure that the lines are far enough from the top so that neither saw nor plane will hit the brads. Also select the hinges and

catch. Make the border beneath the cover wide enough for these. After these things have been done draw the lines with the spur end of the gauge.

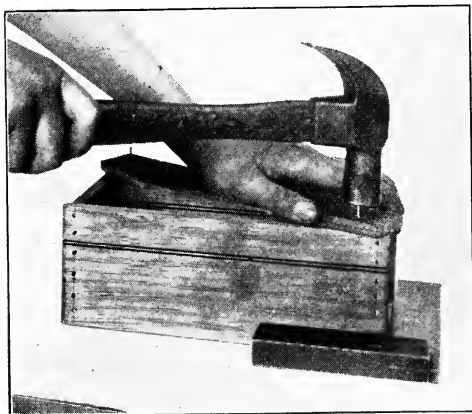


Fig. 292--Nailing Brace

Just when to do sandpapering on such work depends a good deal on the tools and bench you are using. If the bench is clean and you can keep the pieces from being marred or soiled while putting them together, it is bet-

ter to do all the sandpapering at once before doing any nailing. In this case be careful not to injure any of the joints and do no sandpapering on any joint surfaces.

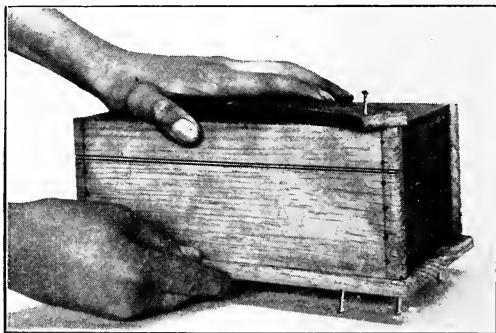


Fig. 293—Adjusting Box Bottom

For this box the joint surfaces are the ends and edges of the end pieces, the edges of the side pieces and the places against which these fit. As you cannot avoid sandpapering these latter surfaces, do so as little as you can while finishing the rest of the surfaces.

Another plan is to sandpaper only the inside or face surfaces and ends of side pieces and both surfaces of the end pieces,

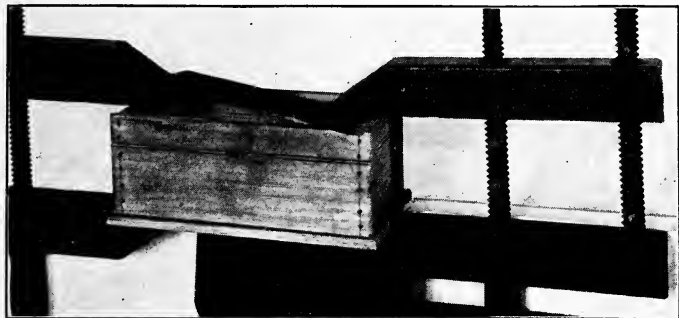


Fig. 294—Clamping Box Bottom

then after nailing these together sandpaper the outside surfaces of the sides.

Sandpaper the inside surface and ends and edges of the bottom, then nail it on. Do the same with the top. After the box is ripped in two and the hinges and catch are in place, sandpaper the top side of the top. The bottom side of the bottom need not be sandpapered.

In nailing the box together calculate the location of the brads and draw a pencil line across the side. Start all the brads for one side, (Lesson 21). Also draw a pencil line on

the face-side at which to locate the inner surface (the face surface), of the end piece. Place the pieces as shown in Fig. 288 and drive one brad near the front edge. Examine it to see that it is even with the line on the face-side and then apply the try-square as shown in Fig. 289. The try-square may also be held as shown in Fig. 290. Next nail the piece to the other end in the same manner. Be very accurate in having the locations of the ends identical.



Fig. 295—Box in Position for Nailing

Place the face-edge of the other side against the one which has been nailed, (Fig. 291) and mark the location for each end. Draw lines across with the try-square and pencil, and also lines for the brads on the outside and nail this piece to the ends.

Test the piece with the try-square and if necessary nail a diagonal brace on what is to be the top as shown in Fig. 292. The brace may be nailed at one end, then after the box is

squared, the other end nailed. The box may be tested for squareness by measuring from corner to corner with a rule or stick. (See Fig. 225.) When both measurements are equal the piece is square, providing the ends and sides are of equal length.

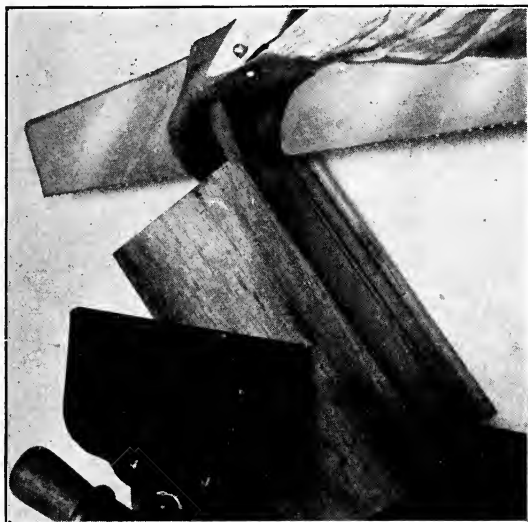


Fig. 296—Ripping Box Apart

The bottom is the next part to be nailed. Its position is located by measuring in from each edge and end. Calculate the position of the brads and draw light pencil lines showing their location. The lines parallel with the edge should be drawn with the pencil end of the gauge and those across the ends with pencil and try-square. Drive the brads so their points

will hinder the bottom slipping, place the bottom on the bench and adjust the body of the box upon it, (Fig. 293). Both can then be turned over and the brads driven home.

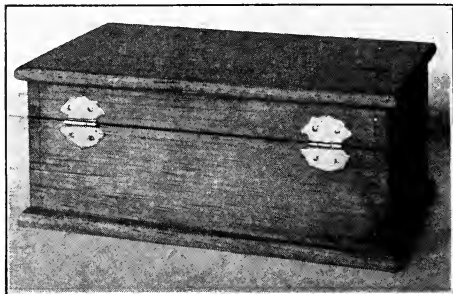


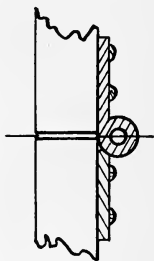
Fig. 297—View of Back of Box

Another method is clamping the bottom in place by securing the lower jaw of a clamp in the vise—placing the box and bottom in the clamp. Tighten the clamp but a trifle, then adjust the parts, and

when the bottom is in place apply another clamp. (Fig. 294).

Release the clamp from the vise and turn the box and clamps over (Fig. 295). Drive at least one brad through the bottom into the edge of each side. Drive one or two brads into each end.

These brads may be driven but a little way into the edges and then the bottom removed and glue applied to hold it more securely, the points of the brads helping to find place and keep from slipping. The brads should then be driven and set. The securing of the bottom will hold the box square and now the brace (Fig. 292) can be removed. Then the top should be nailed, or nailed and glued, into place in the same manner.



*Fig. 298
Sketch of Hinge*

To rip the box in two, place it in the vise (Fig. 296), the same as the piece (Lesson 20), and work very slowly, reversing the box the same as a solid piece. Plane the edges to a tight joint and then put a clamp on each end of the box (Fig. 295), to hold the two parts in place as you nail on the hinges and catch. Fig. 287 shows the catch in position. There is little need of directions for putting on this style of fastenings. They should be carefully located on the joint. It is especially necessary that the hinges be in exact line and the center of the pins on which the hinges turn be exactly over the joint. Figs. 297 and 298 indicate how the hinges are located.

LESSON 65

WAGON BOX

The wagon box follows the same general plan of construction indicated in Lesson 64. The corners should be carefully



Fig. 299—Wagon Box

nailed, and it will look better if the sides extend beyond the ends as in Fig. 287. The rear end of the box may be made as shown in Fig 299.

As you will wish to use this box on your wagon you will plan all dimensions to suit your needs. First lay out the sizes you want, making a rough sketch. Then look over the material you have and change your plans, if necessary. Make a complete drawing before beginning work. Be sure to read all the directions for planing, sawing, sandpapering and finishing before beginning work, so as to insure the making of a nice box. Do not try to do this problem until you have solved several simpler ones including the first study piece.

LESSON 66

NAIL BOX

Nail boxes are, of course, varied as to size and number of divisions to suit the sizes and varieties of nails to be held. For ordinary use the simple butt joints, as shown, are sufficient.

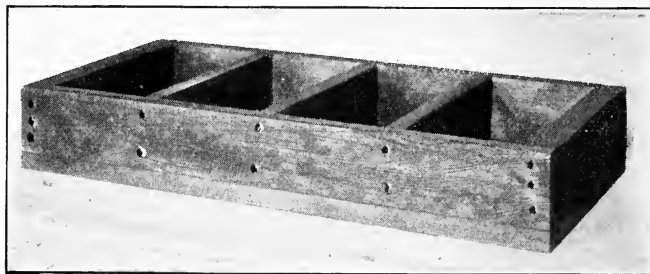


Fig. 300—Nail Box

After you have learned to use a larger variety of tools you can make nail boxes containing more difficult joints.

The box shown in Fig. 300 is similar in construction,

adding partitions and omitting the cover, to that illustrated by Fig. 287. By following the directions given in Lesson 64 you will no doubt make this nail box in first class shape. If you do not want the size shown in the drawing, Fig. 301, make a drawing to suit your wishes. The partitions should

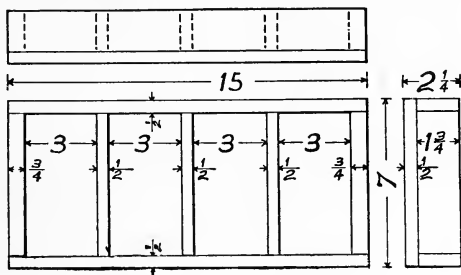


Fig. 301—Nail Box

be made at the same time as the ends and all lined for length at one time the same as the rails (Fig. 182). You must then work exactly to the knife lines. The difficulty is to stop at the line.

LESSON 67

NAIL BOX

Before attempting to make a box of this type you should make one similar to Fig. 287 or Fig. 300. This will help you to understand how this box is made. Follow the same directions for making the sides and bottom.

The ends are made so that the grain of the wood is vertical instead of horizontal as in Fig. 287. In shaping the ends you follow the same method as in making the other pieces except that you follow the directions in Lesson 29 for cutting off the corners.

The drawing, Fig. 303, shows a partition beneath the handle lengthwise of the box. This may be omitted or it may

be placed crosswise of the box as in Fig. 300, or two or more partitions may be used. These may be all of the same height

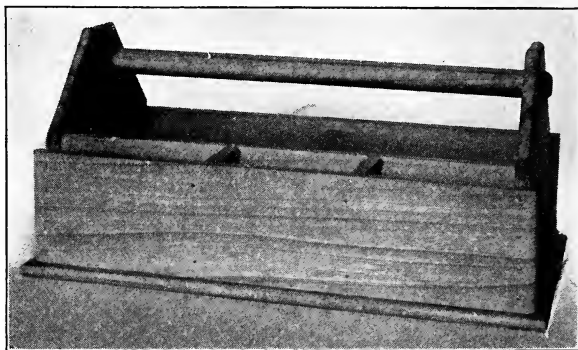


Fig. 302—Nail Box

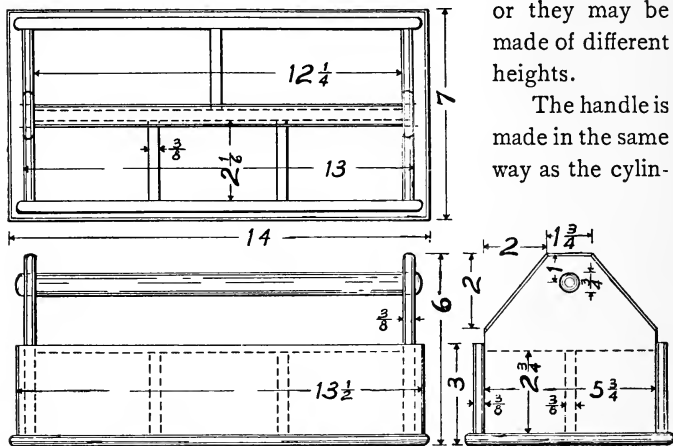


Fig. 303—Nail Box

or they may be made of different heights.

The handle is made in the same way as the cylin-

der, Lesson 68. It is slipped into the ends before they are nailed to the sides. A brad may be driven into the handle to prevent turning.

LESSON 68

CYLINDER

The making of a cylinder by planing is not a difficult task if you are careful to first make the piece exactly square in section, then octagonal and continue to increase the number of sides systematically, being sure all sides are alike before proceeding to the next larger number.

After the piece has been made an exact square by following the directions for planing and testing (Lessons 4 to 11) make it into an octagon.

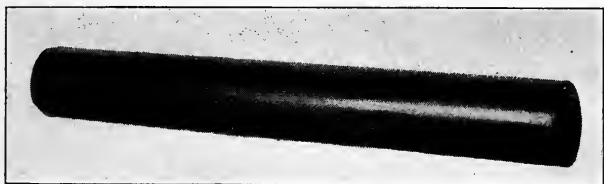


Fig. 304—Cylinder

To lay off the octagon place the piece on the bench and hold the rule on it as shown in Fig. 305. Turn the rule to such an angle as will use ten of the regular divisions of the scale in the width of the surface. If the piece is $\frac{1}{2}$ inch wide you can turn the rule until 10 of the $\frac{1}{16}$ -inch divisions will extend exactly across. If it is 1 inch across, the rule should be turned to use 10 of the $\frac{1}{8}$ -inch divisions. By this method

you have an easy way of getting three-tenths of the width, for after placing the rule so that you have ten equal divisions, you can mark off from one edge, three of these divisions, or three-tenths of the width.

Set the pencil end of the marking gauge and line each corner of the piece. Hold the gauge against each corner in succession without regard to the face-marks. Roll the piece until each side has one line upon it, then reverse the piece end for end and draw the other four lines.

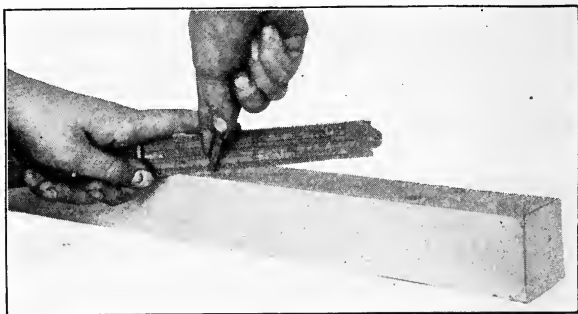


Fig. 305—Dividing to Get Three-tenths of Width

These lines, if you have done the work properly, will be the guides for planing the octagon. Plan to leave the lines, planing only to them. There are two reasons for doing this, first, it makes easy the finding of any error in your work and, second, the fraction, $\frac{3}{10}$, is a little too large.

A better spacing to use on larger pieces is seven twenty-fourths, but for small pieces a three-tenths division is better. Yet another method of making an octagon is shown in Lesson 61.

To plane the corners off, the piece may be held in the vice as shown in Fig. 306 or against the stop as shown in Fig. 307. Place an X on each surface between the gauge

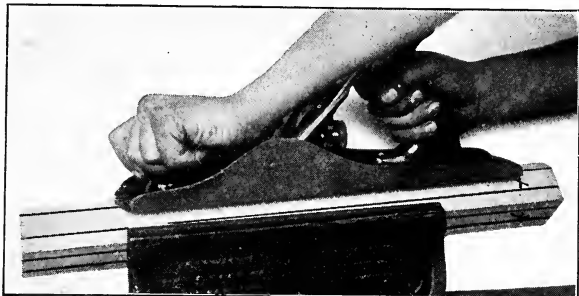


Fig. 306—Planing an Octagon

lines so as to easily distinguish the original four sides after the corners have been planed off.

Test every side by measuring with the rule, holding it in

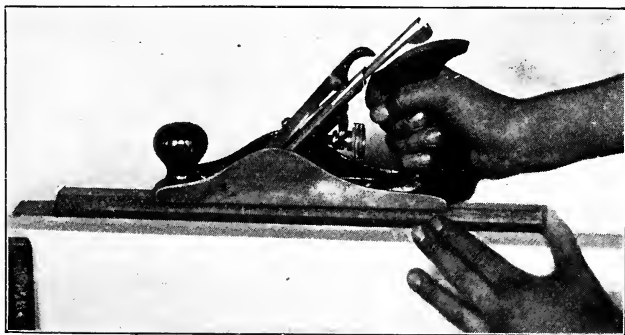


Fig. 307—Planing an Octagon

the same manner as in measuring the chamfer (Fig. 86). All the sides should be of the same width. If they are not, look carefully to find where the mistake is and rectify it if you can.

Test the octagon by holding the try-square the same as in testing a chamfer, Fig. 84. Any variations in the octagon will show in the cylinder, therefore be particular about making each side of the octagon exactly correct. (Fig. 308).

Next, plane off each corner of the octagon, making a piece of 16 equal sides. If this does not make the piece as nearly round as you can plane it, plane it to a 32-sided piece. The

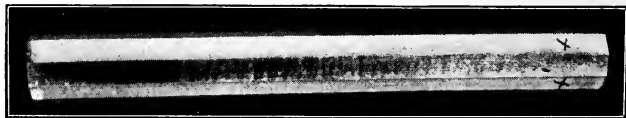


Fig. 308—Octagon

larger the piece the more sides you can make with the plane before it appears to be round. For small pieces, such as dowel rods, 16 sides is usually enough; for larger pieces you may be able to make 64 or even 128 nicely formed surfaces. The longer you continue making regularly formed angles the better cylinder you will make and the quicker you will complete it.

After you have made as many regular sides as you can, look for any irregularities and plane them down. This part of the work should be well done, for no amount of sandpapering will take the place of careful planing.

After the planing is finished, sandpaper the cylinder as

directed in Lesson 25. Be careful to keep it straight to the ends. In cutting off the ends of a cylinder it is well to clamp it

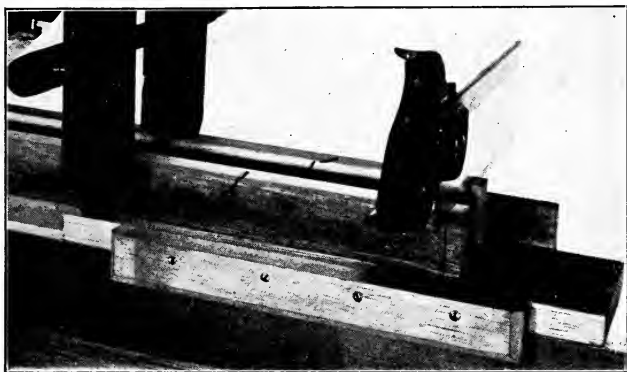


Fig. 309—Sawing End of Cylinder

between two pieces as shown in Fig. 309 and draw lines on the pieces to saw by. Saw very slowly to avoid slivering.

LESSON 69

TOWEL ROLLER

Fig. 310 illustrates the towel roller and Fig. 311 is a mechanical drawing of it. The size and shape may be modified to suit.

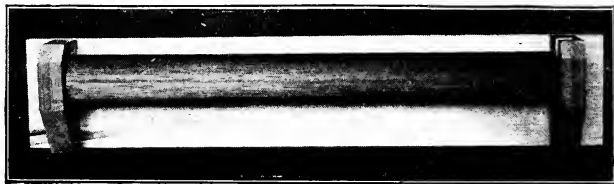


Fig. 310—Towel Roller

The back or main part requires the same working as the bench-hook.

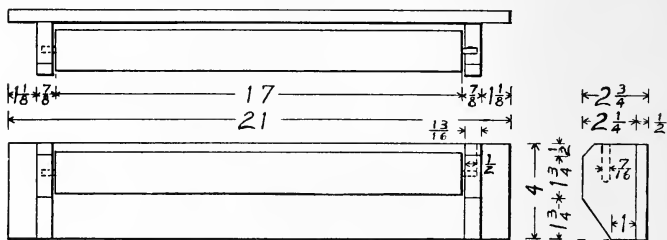


Fig. 311—T-cwcl Fol'cr

The ends or bracket pieces may be made in the same manner as the brackets (Fig. 163).

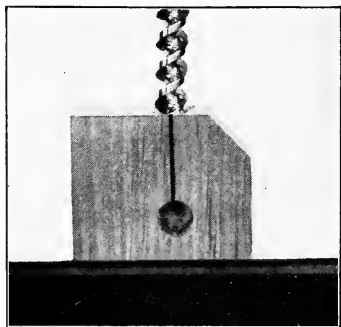


Fig. 312—Boring Slot

The new features in the construction are the roller and the slot into which the roller fits. The directions for making the roller are found in Lesson 68. After the roller has been made holes are bored in each end and hardwood dowels inserted to form the bearings. To find the center, measure across the end in several directions, each time marking the center.

Bore the hole as directed in Lesson 28 on boring.

To make the slot in one of the brackets, after a hole has been bored in from the side at the point for the bearing, bore a

hole in from the top end meeting the hole which is to form the bearing. (Fig. 312). Bore this hole so that little material will need to be removed, in addition to the boring, to complete the slot. The slot can then be finished with a knife.

Fasten the brackets in place by nailing and gluing. Be sure that each part is properly sandpapered before the whole is put together.

LESSON 70

REVOLVING BOOK RACK

This is an easy article to make if you can do good planing. If you have made the study piece and bench-hook properly you

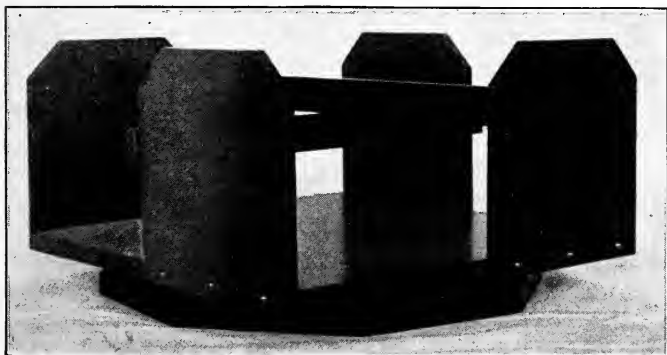


Fig. 313—Revolving Book Rack

can, with careful work, make this book rack. Do not attempt it until you are able to control your plane, for if you attempt to square the ends or joint the edges of the thin pieces before you have a thorough understanding of the elementary principles of

planing you may form bad habits that will cause much trouble. If you make one of the waste paper baskets first, you will receive a larger benefit from making the book rack.

The base is made in the same manner as the octagonal bottom of the basket (Lesson 61). For directions for chamfering it, review directions in Lesson 18. The bottom of the revolving part is made the same as the cutting board. Be sure to make this piece true and square in every particular, for unless it is correct the sides may not fit properly.

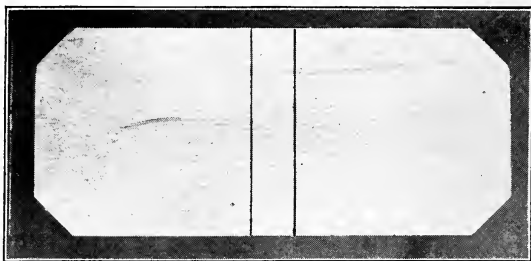


Fig. 314—Piece for Ends of Book Rack

The ends are easiest made by dressing up two pieces, each long enough for two ends, finishing them as in Fig. 314 and then cutting them in two. This will be much easier than attempting to work each end from a short piece. If you have a piece which is very straight and out of wind and long enough for all four, you can dress it to size and finish two ends, cut them off and then finish the other two. This is the quickest way if you have a piece sufficiently straight.

The two cross strips should be worked as one wide piece,

the ends squared and rounded (See Fig. 149) and then ripped apart and the remaining edges jointed.

Lay off and bore the hole in the center of the octagon and countersink for the screw head. If you use a $\frac{1}{4}$ inch bit it will be the correct size for the shank of a No. 12 screw. Find the center on the bottom side of the square piece and bore a hole for the threaded part of the screw. Plan to use a screw that will reach nearly through the piece. If the pieces are $\frac{7}{8}$ inch and $\frac{1}{2}$ inch and the countersink is such that the head is barely below the surface, a $1\frac{1}{4}$ inch screw will be the correct length. By making the countersink deeper a 1 inch screw can be used. The head must be enough below the surface to allow for the screw turning without injuring the surface on which the base rests.

Lay off and bore holes for the screws in the upright pieces. These should be for No. 8 by $1\frac{1}{2}$ inch round head screws. After the holes have been bored, place the piece in position and mark the places on the edge for the screws. Number the ends and the bottom so that they can be returned to the same places. Bore the holes and insert the screws, for this you will need the automatic drill (Fig. 187).

Drill two fine holes in each end of each cross piece for the brads. Nail these to place, testing the sides with the try-square to see that they are at right angles to the base.

This Rack may be made of soft wood or any cabinet wood. It may be finished in any of the ordinary finishes. If varnished a felt washer about 3 inches in diameter should be placed around the screw, above the base. For other finishes a piece of thick paper will be sufficient.

The base of Fig. 304 is 12 inches across and $\frac{7}{8}$ inch thick.

The square revolving base is the same size and $\frac{1}{2}$ inch thick. The ends are $5\frac{3}{4}$ inches long, $5\frac{1}{4}$ inches wide and $\frac{3}{8}$ inch thick. The cross rails are $13\frac{1}{4}$ inches long, $\frac{7}{8}$ inch wide $\frac{1}{4}$ inch thick.

The sizes given make a very nice rack but may be changed to sizes suitable for 8vo. or larger books. The same plan of construction can be used in making a rack of two shelves, one above the other.

Another and simpler modification is to use but two vertical pieces. These should be wide enough for two rows of books. They should be fastened to the ends of the lower piece to keep it from warping.

To support the ends and furnish a division between the two rows of books, rods are placed across the center and extended through the sides to receive pins, as in Fig. 235, or a board may be fitted between the uprights and held in place with screws.

The directions for making this book rack and Fig. 209 include all the essential information for making a variety of simple racks. Ends similar to Fig. 314 may be used in place of the frame ends in Fig. 209. They would then be made of $\frac{3}{4}$ inch stock and held in place by screws passing up through the bottom into the lower ends of the end pieces or supports. The base for such a rack may be plain rectangular or chamfered around the upper surface. The end supports may be the same width as the base or a little narrower. They must be narrower if the edges of the base are chamfered.

The end supports may be fastened to the ends of the base similar to an end in fig. 313. As there would be no cross rod to hold the ends in place larger screws must be used. The ends may extend below the base and form legs.

LESSON 71

SHOE BOX

Fig. 315 illustrates a box suitable for shoes. Fig. 316 gives the sizes. Carefully study Lessons 38, 39, and 40 before beginning this box.

The four pieces which form the sides and ends are the first ones to make and should be carefully dressed out of wind and



Fig. 315—Shoe Box

squared on edges and ends. To bevel the ends of the side piece, follow the directions on page 144 (Fig. 198). The nailing together is done in the same manner as the nailing of the rails for the taboret (Lesson 40). Dowels may be used as shown in Fig. 200.

Although no glue blocks are shown in the corners, they may be used as in Fig. 199. Plane the rough surface of the block by holding the piece against the stop, Fig 307, or tack two triangular pieces on a board as shown in Fig. 317. If holes are to be bored for screwing or nailing on the legs do not put any nails into the glue-blocks until all the boring at the corners has

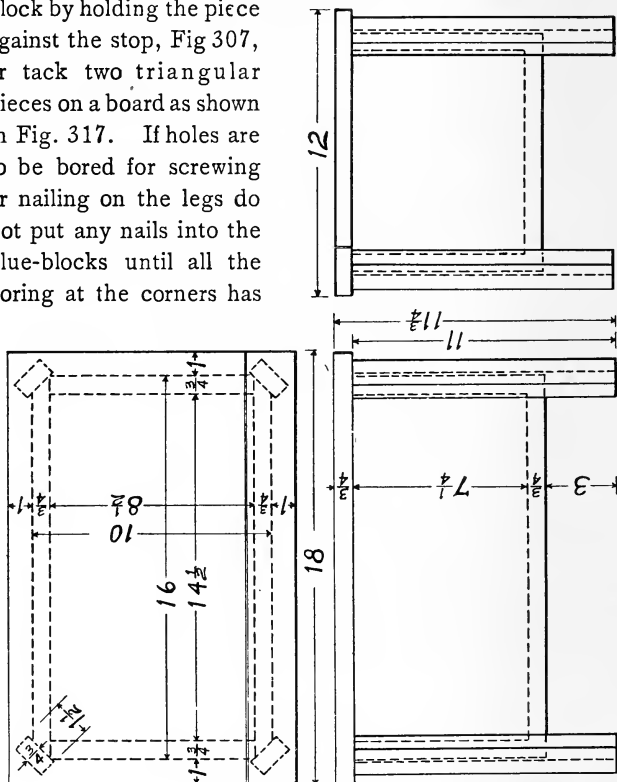


Fig. 316—Shoe Box

been completed. Remember to leave the glue-blocks short enough to allow the bottom to rest against their lower ends.

To make the bottom, dress one surface, one edge and one

end. See that the finished corner fits a corner of the box and mark so that you can always place it in the same position. Mark the length of the bottom at each edge, draw a line to these marks and then saw and plane to the line. Mark the width in the same manner and rip and plane the edge.

Make the legs as directed for Fig. 180 or Fig. 195. If tapered they should be first made straight and then tapered. (See Lesson 50).

The top is of two pieces of equal thickness hinged as in Fig. 318. The width of the two parts is not material, except that the narrow piece should be wide enough to receive one end of a hinge. Some hinges are made with the two parts differing in length, there-

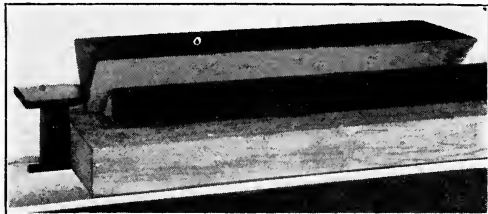


Fig. 317—Planing in Trough

fore it is best to procure the hinges and fastenings before making the drawing. Instead of the catch shown in Fig. 319 a hasp and pad lock may be used. Do not attempt to use any hinges or locks that necessitate the cutting of the wood to fit them to place. The use of such hinges and fastenings belongs to the more advanced problems. To hinder the lid opening so far as to strain the hinges a chain is fastened to it and the end or front side of the box. Jack chain can be used for this purpose. It should be securely fastened or it will soon come loose.

This box may be modified in many ways to adapt it to

other uses. The sizes may be changed to those of a large chest, or to those of a jewel box. Ornamental corner pieces may be substituted for the legs, or the corners may be left square and covered with ornamental metal work. If the corner

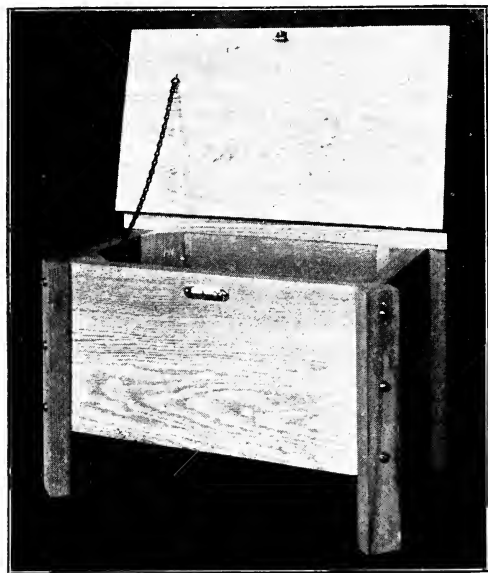


Fig. 318—Shoe Box

is trimmed as in Fig. 315 and only a thin piece used in place of the legs a one piece top may be used. The sides may be rounded and extend beyond the ends the same as Fig. 287. This would require a longer top. The bottom would be the same as in Fig. 316.

If you make a large box you must be careful to use dry lumber. Some boards will warp or twist much more than others. Try to get those that will remain straight. You can get some idea of what boards will warp and what ones will not by examining them in the pile or by laying them out where you can watch them.

LESSON 72

TABORET

These taborets, Fig. 319 and Fig. 322, show forms of construction which may be applied to a large variety of tables and taborets and similar articles. Before attempting to make these you should have learned to plane, saw and bore holes.

The top may be octagonal, as shown in Fig. 319, or square, Fig. 320, or hexagonal. The block into which the rails are fastened is of the same shape as the top. The size and number of rails for each leg may vary.

The legs of Fig. 319 may be fastened to the top with dowels, as shown, or with two round head blued screws in each leg. Directions are found in the general directions for using screws and in Lessons 38 and 39.

To locate dowels draw a line across each leg at the point which will be opposite the center of the edge of the top, also mark the center of width of the leg. Locate the center in length of the edge of the top and place this point opposite the center line on the leg (Fig. 321). Make a mark with the point of the knife for each dowel, marking on the line which



Fig. 319—Taboret

is on the leg and that on the edge of the top. With knife and

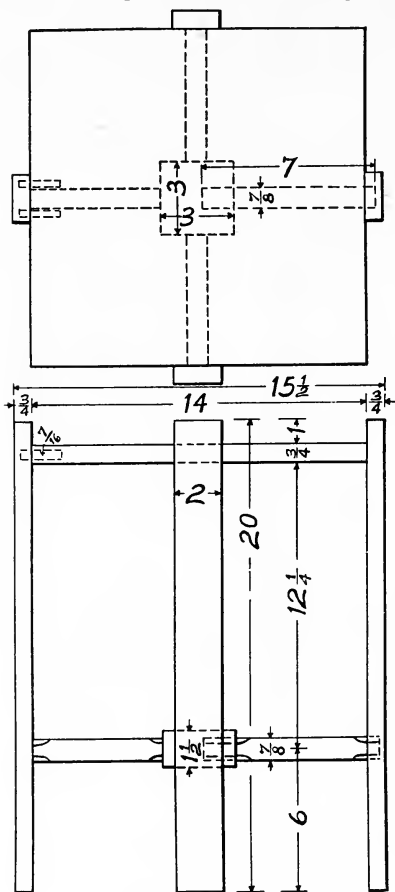


Fig. 320—Tabo'et

try-square extend the marks on the edge across the center line. At the points where these lines cross and at the line on the legs the holes for the dowels should be bored.

Bore the holes into the edge of the top about two inches, and into the legs as far as you can without leaving a mark from the spur of the bit. Lesson 35 gives quite full information regarding dowelling.

Try the parts together and if they are correct take them apart and smooth them ready for the stain or finish. See Lessons 25 and 36.

Glue the dowels into the legs first; straighten them carefully and allow them to dry. Then glue the cross rails or spindles into the legs and center block and at the same

time glue the legs to the top. Look carefully for wind and test thoroughly with the try-square at both top and cross rails.

Glue-blocks may be used where the legs join the top, the ends of blocks being well smoothed. They may be nailed or only glued and clamped.

In all your designing or modifying of the given designs you should be careful to consider the matter of strength. This is controlled not only by the sizes of the parts, but also by the methods of joining. Before making any radical changes in the design you should study thoroughly all the forms of joining given in the text.

This will include dowelling, blind screw (Fig. 171), nailing, gluing, blue head screws, round joint, pinned joint, etc. Each



Fig. 321—Marking for Dowels

of these methods has its advantages and limitations. It is for you to learn the features of each and then make use of those best suited to your project. Do not consider your drawing complete when you have only the outline of each part, but plan every joint and show in the drawing how it will be constructed. Your best method of determining the sizes of the joints, nails or screws to use is to study those given and determine the sizes in your project by comparison. Leave no designing to be done while you are at work making the taboret or other article or you will fail to get the largest benefit from the work.

LESSON 73

TABORET

This problem is a review on planing surfaces and ends (Lessons 1 to 28), working angles (Lessons 49 and 62) and the making and use of spindles (Lessons 42 to 45).

The top may be square or octagonal and the legs may be set as in Fig. 322 or Fig. 323. By comparing this design with

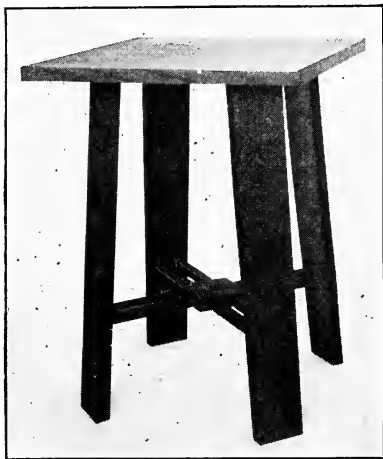


Fig. 322—Taboret

Fig. 319 you will understand that it is similar in plan of construction, the chief difference being the use of parts not at right angles. By studying this design and comparing it with others you will be able to work out new designs from such right angle constructions as Figs. 203, 209, 232, 256, etc. Notice that in all these constructions the angle is on but one side of the piece. This is as difficult a problem as

you ought to attempt at this time. A change from four to three, five or six legs in problems similar to Figs. 319 or 322 is possible without meeting any problems for which you have no instructions. The glue blocks to which the legs are fastened should be first secured to the ends of the legs by either

gluing and nailing or screwing. They are then dressed on the side which fits against the top to the exact angle required, and the holes bored for screws for fastening to the top.

Lines should be drawn on the top for the outside surface of the legs and also for the edges. Make the center block and spindles. Glue them together.

Bore holes in the legs and

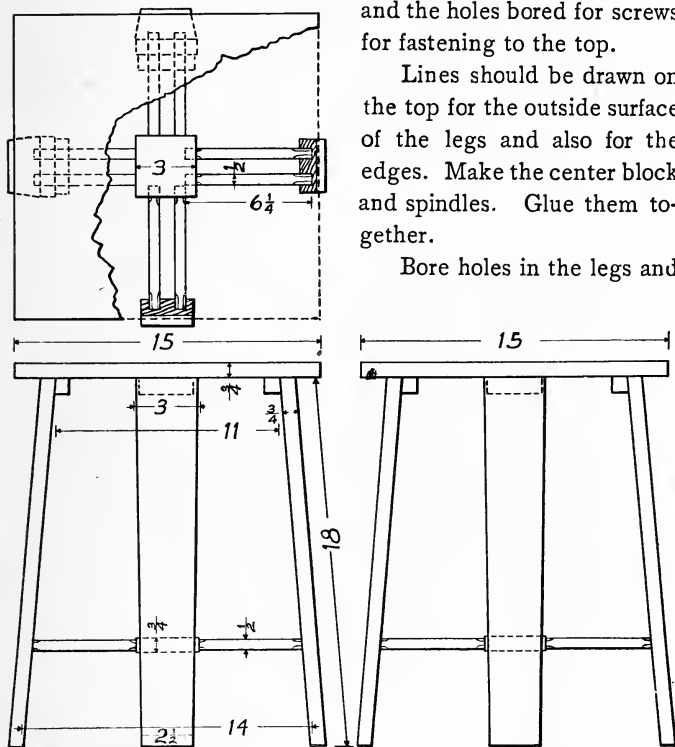


Fig. 323—Taboret

insert the spindles. Place the legs in place on the inverted top and test each angle carefully. Adjust the legs to the lines on

the top, if you can, and if not, make such variations as are necessary to bring the legs out of wind and to the proper angle.

Mark the positions for holes for screws in the top, separate the pieces and bore the holes, and then smooth and sandpaper all the parts.

In clamping, first force the spindles to place and then quickly insert the screws. After the screws are in place adjust the joints at the spindle ends and finish tightening the screws.

LESSON 74

LAMP STAND

This lamp stand (Fig. 324) is an advanced study in planing, chamfering and making glue joints, and should be preceded by all the work to Lesson 20.

The beauty of the stand depends upon perfect finish, and exact shaping of edges and chamfers. It is not difficult if you understand the work, but cannot be well done by piece-meal, puttering methods.

Each piece should be made according to the drawing, (Fig. 325) or to a drawing of your own, if you prefer to change the design. Many changes of design are possible which require the



Fig. 324—Lamp Stand

use of no tools not used in making this. In making the column, glue two pieces to one side (Fig. 326) and then dress them to a taper that will allow of the proper thickness for the remaining side. You will find help in making this column by the study of directions for the column in Lesson 41.

In squaring the ends use a block on the head of your try-square the same as in working the angles in Lessons 49 and 62.

The parts are fastened together with screws. These screws should be used in the base of the column, four in the bottom board and three in the column top. After the top is secured to the column the thin piece is glued on, covering the screw heads.

After all the parts are made and fastened together they should be taken apart, except the pieces on top of the column, and sandpapered. Read Lesson 25 before attempting to use the sandpaper.

Some of the changes which can be made are an increase or decrease of the sizes, keeping the proportions the same, a change in the outline by using another form of ornamenting the corners, the making of all the parts octagonal, or of some other outline instead of rectangular. Sometimes cross-arms are fitted to the column to support the shade, or the

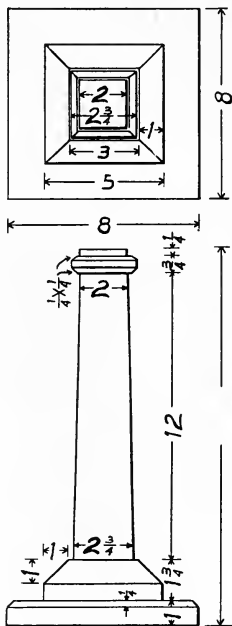


Fig. 325—Lamp Stand

frame of shade is made of wood. Such constructions are not most suitable for such pieces. It is better to make both



Fig. 326—Gluing up Column

the shade frame and its supports, or attachments to the column, of metal.

LESSON 75

UMBRELLA STAND

There is little about the making of this umbrella stand (Fig. 327) with which you are not familiar except the legs. These are the first parts to make, as they require clamping, and you can then work on the other parts while the legs are in the clamps.

In making the legs, after the stock has been cut to rough length, joint a side and edge of each piece. The side first jointed will be the inside of the leg and therefore you must plan so that the best part of the piece will be at the back side. The edge first jointed will be the outside edge on the wide piece. The edge which fits against the wide piece will be the face edge of the narrow piece. Plan so that the best surfaces will be where you want them to be.

Glue the pieces together before tapering them. In order

to hold them easily while gluing, drive about four brads along each corner. Start these brads before applying the glue so that after the glue is on the surfaces the brads will re-enter their places and assist in adjusting the corner. Two legs may be clamped at a time, as shown in Fig. 329. As these pieces are thin and easily sprung you



Fig. 327—Umbrella Stand

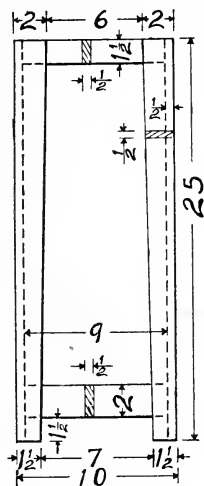


Fig. 328—Umbrella Stand

must use plenty of clamps. The next step is to taper each piece of each leg. Mark the width at each end and with a straight-edge draw a line as shown in Fig. 330. Plane, or saw and plane, to this line.

The rails for the umbrella rack are made in two sets of four

each. — By completing the drawing (Fig. 328) you can learn why the rails differ in length. These rails may be made by following either of the methods given for making the rails for Fig. 180.

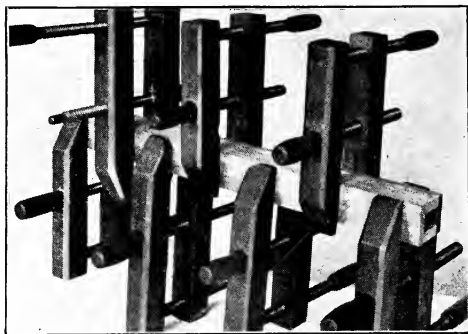


Fig. 329—Clamping Legs

As there are to be four pieces of a length, it is essential that you be very careful about your end planing. You should not attempt to do the work until you have learned to end plane on larger ends.

Nail the four legs into two groups, testing thoroughly for wind (Fig. 189) and squareness. They may require clamping as shown in Fig. 331. After each pair is nailed and glued and dry, nail the two pairs together. These will likely also require clamping.

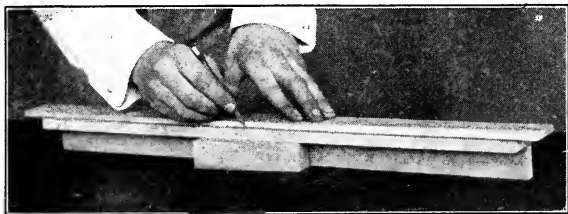


Fig. 330—Lining Taper

The square pans for the bottom may be made of copper or of cast iron as shown in Fig. 251. If of cast iron, a pattern is made and the pan cast in the usual way.

This stand may be modified by changing the sizes of the various pieces, or by using more or ornamental cross rails. The posts may extend above the top rail or they may be solid



Fig. 331—Clamping Rails to Legs

and the rails pass around them. The corners and rails may be secured by ornamental wrought nails, or held entirely with glue. This latter plan should be used if the stand is of hard wood, especially if mahogany.

Study the designs Figs. 250 and 252 and then try to make a new design.

LESSON 76

TABLE

This table (Fig. 332) is quite difficult because of the glue joints in the legs. The construction at the corners of the frame is shown in Fig. 333. The legs, which are the first

parts made, are worked the same as those for Fig. 327. Another plan which is often used is to select stock wide

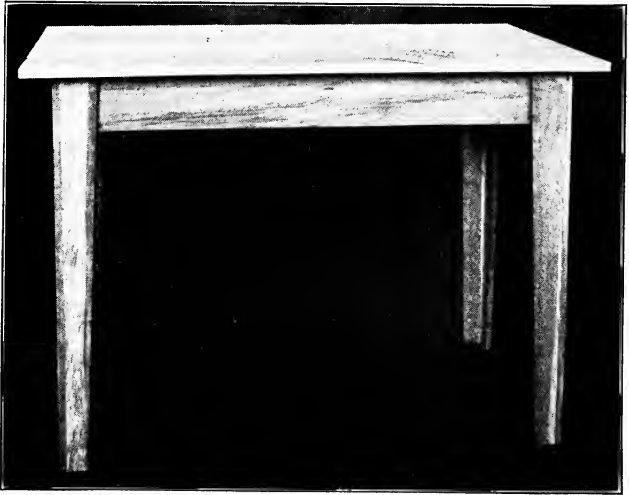


Fig. 332 – Table

enough for a leg by lining and ripping as shown in Fig. 334. Be careful to plan the ripping so that the sides will face correctly when put together. One face and both edges should be jointed before the piece is ripped.

All four legs may be clamped at once by placing two large and two small ends each way. Start three or four brads into the edge and place the piece in position. Drive the brads into the other piece enough to make sure that they

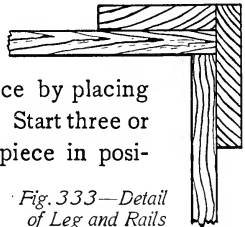


Fig. 333—Detail of Leg and Rails

will hold the piece from slipping, but not far enough to hinder separating the pieces for applying glue. Test the joint on the inside with the try-square at several places as shown in Fig. 335. Separate them and apply glue and then clamp them.

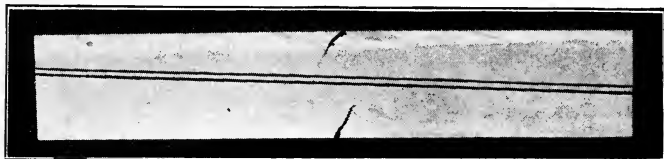


Fig. 334—Piece Lined for Ripping

The rails are made in the same manner as other small pieces. Clamp *each pair* together and line them so that those for each *set* will be of equal length.

In putting the rails and legs together, nail and glue each joint. First secure the end pieces, making two pairs of legs, Fig. 332 and then fasten the pairs together. The rails should be sandpapered before they are put in place. The top is made and fastened to the frame the same as in the taborets.

The design may be modified by changing the dimensions, for this method of construction is applicable to tables of

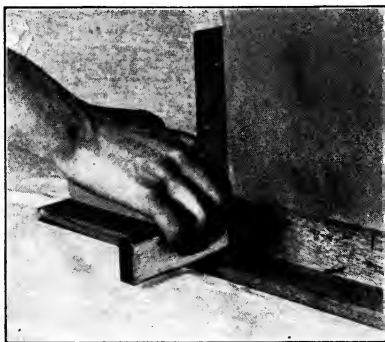


Fig. 335—Testing Joint

any size. In this lesson the stock is $\frac{1}{2}$ inch thick. The top is 23x39 inches. The legs are 28 inches long and 3 inches wide at the top and 2 inches wide at the bottom. The rails are 4 inches wide and 35 inches and 18 inches long. A table with a top 20x36 inches makes a very good writing table for school work. Larger sizes should be of $\frac{7}{8}$ inch instead of $\frac{1}{2}$ inch stock. Reduced to 10 inches square by 16 inches high the frame is suitable for a taboret.

If this design is well executed and finished in hard wood, it makes a very handsome and serviceable table.

LESSON 77

SLED

The question is not "how to make a sled," but "how to make a sled without attempting some problem of tool usage not to be undertaken at this time." This sled (Fig. 336) is

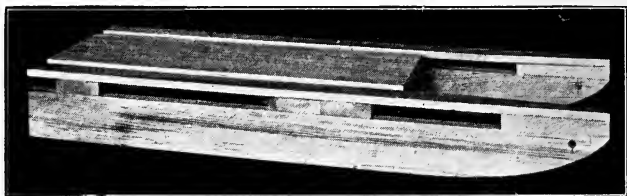


Fig. 336—Sled

so planned as to be serviceable and yet require only simple problems in construction. The drawing, Fig. 337, gives the dimensions of Fig 336.

Before undertaking this problem you should have made at

least the first study piece and the bench-hook. Remember that you are studying, and try to learn all you can while making the sled.

Examine the picture and the drawing and try to discover *why* each part is so made. After you determine the reasons for making this sled in this manner and of this size, go over each part of the plan and see if the reasons for this size or form hold good for making a sled for your own use. Do you need a sled as long, as high or as strong? Perhaps you will need to make your sled much stronger; if so, what changes should be made.

The runners may be made first. Be sure to make them smooth on all surfaces. The curve should be drawn free-hand either on paper and the runner marked from it, or on one runner and after this one is formed the other marked from it. Study Lesson 32 and you will have all the directions you require for planing the curves.

The beams are simply straight pieces of rectangular section. They must

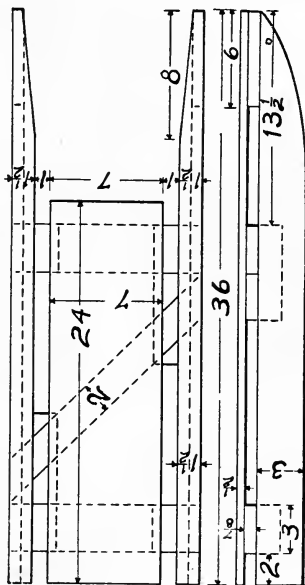


Fig. 337—Sled

be well made, with edges and surfaces true, for if in wind or not square you may have trouble in squaring the parts when you put the pieces together. The beams may be worked in one piece and then ripped apart, as the rails or legs for Fig. 181. Be sure to make the ends square and smooth for it will add much to the appearance of the sled.

For the triangular brace strips make pieces in the same manner as the glue blocks, Lesson 38. They should be of wood free from checks or shakes, and not liable to split.

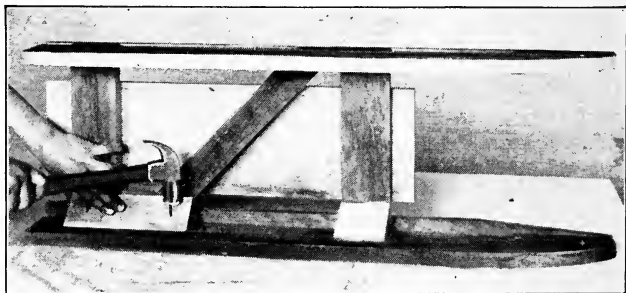


Fig. 338—Nailing Brace Blocks

These blocks are to keep the runners square with the beams and often have to resist considerable strain when the sled turns or tips over. They should be thoroughly fastened to the runners as well as to the beams and braces (Fig. 338).

The top board may be plain square or with corners cut off. The runners should be of stout wood, carefully made and securely fastened.

Before putting the parts together read about screws and how to use them. Fasten the beams onto the runners, then

the blocks into place; next fasten the braces and finally the top board and raves.

The sled is usable without iron shoes, but will slip easier if a strip of iron is fastened on the lower edge of each runner. Thin hoop-iron can be used for this purpose and is held in place with nails, though flat band-iron, half round or half oval iron, thick enough to receive countersunk holes for flat head wood screws is far better.

The curve at the front end of the runner may include the block and rave. This will not be as strong a construction and should not be used unless there is an iron shoe to extend up over the end and fasten to the top of the rave.



INDEX

Adjusting Plane	20	Curve, Working of	117, 189
Arc	117	Cutting Board	92
Automatic Drill	136	Cylinder	219
Ax	15	Design	13
Back Saw	60	Dodecagon	207
Bench Hook	65, 66	Doweling	123, 143, 233
Bench Hook Sides	74	Drawing Circle	117, 178
Bisecting Hexagon	207	Drawing	67
Bit	10, 107	Drawing Gauge Lines	46, 49
Blind Screw	126	Drilling Holes	135
Blotter Pad	189	End Planing	69
Book Rack 151, 164, 168, 172, 225		Escutcheon Pins	197
Boring	107, 109, 135, 145	Face-Edge	38, 40
Boring at Angle	174	Face-Marks	37, 42
Box	207, 232	Face-Surface	37
Brackets	120	Facing Strips	150
Brads	8	Finishes	11
Bread Board	110	First Edge	40
Chair	186	Flat Head Screw	9
Chamfering	75, 76, 191	Footstool	122, 155
Chest	232	Framing Square	29
Circle	178	Gauge Spur	43
Clamping		Gimlet Bit	10
145, 149, 163, 182, 186, 211, 242, 243		Glue Block	138, 145, 230
Compasses	178	Gluing	240
Cord Hinge	183	Grain of Wood	26
Countersink	11	Grinding	91
Counting Board	105	Hammer	82
Cross Cut Saw	16	Hand Saw	77
Cross Planing	94	Hexagon	176

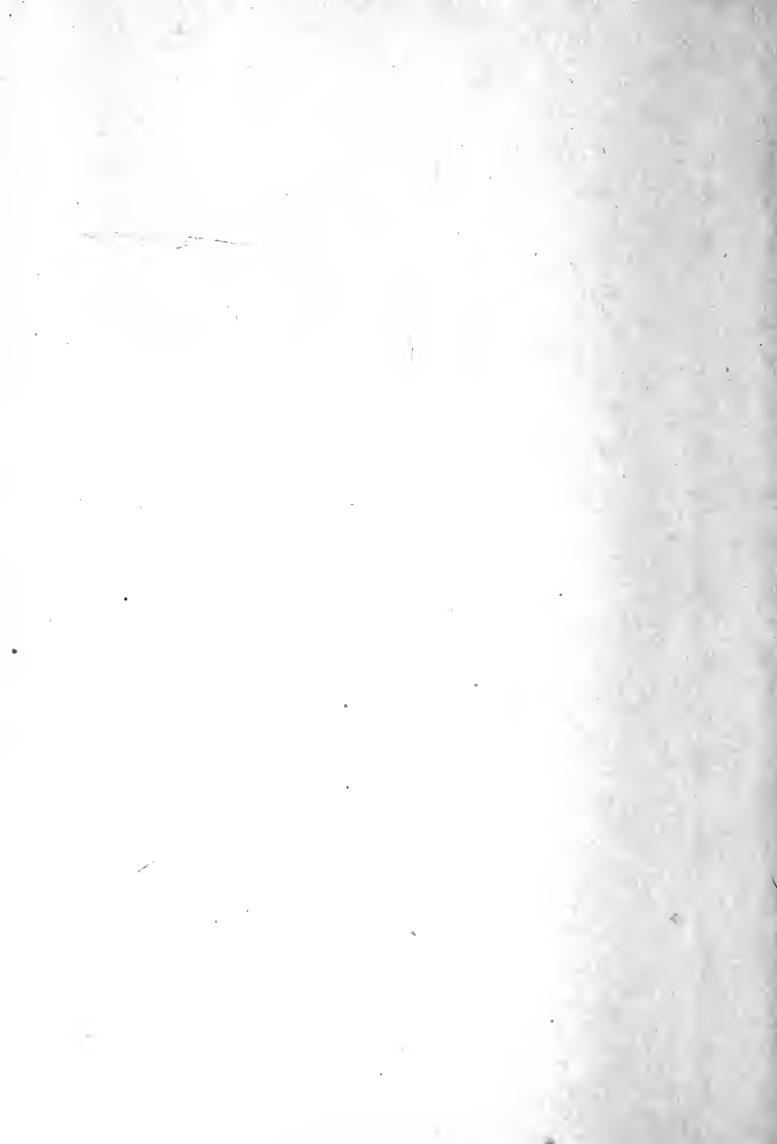
INDEX—Continued

Hinge 183, 185, 214, 215	Nail Set 85
Inspecting Material 17	Needle 162
Jack Plane 19, 33	Octagon 202, 222
Jointing Edge 40, 49, 68	Octagonal End 153
Jointing Ends 69, 144	Outline 64
Keeping Plane Sharp 38	Oval Edges 121
Knife 54	Paint 12
Lamp Stand 238	Pan for Umbrella Rack . . . 179
Lacing 205	Pedestal 147
Laying off Spaces 53, 55	Pencil Gauge 43
Lining at Angle 111, 120, 174, 245	Pine 16
Lining Corner 111, 146	Plane 19
Lining Ends 132, 141	Planer (See Surfacer)
Lining Legs 141	Plane Bit 20, 87, 88
Lining around Octagon . . . 200	Plane Parts 20
Lining Taper 242	Planing . . 20, 23, 25, 29, 33, 36, 49, 51
Looking for Wind 36, 137	94, 112, 115, 118, 144, 146
Lumber 15	167, 189, 190, 203, 221, 231
Machine Marks 18	Planing Ends 69
Magazine Rack 166	Plant Stand 176
Mantle Shelf 119	Plate Rack 170
Marking Gauge 43	Pocket Knife 54
Marking by Superposition . . 157	Pocket Rule 44
Match Safe 199	Polishing 190
Match Strike 198	Publisher's Note 3
Measuring Width With Rule . 50	Radius 117
Milled Thumbnut 21	Rails 130
Nails 7	Reed Footstool 155
Nailing . . 82, 171, 208, 210, 248	Revolving Book Rack 225
Nail Box 216, 217	Ripping . . 78, 81, 118, 132, 139, 213

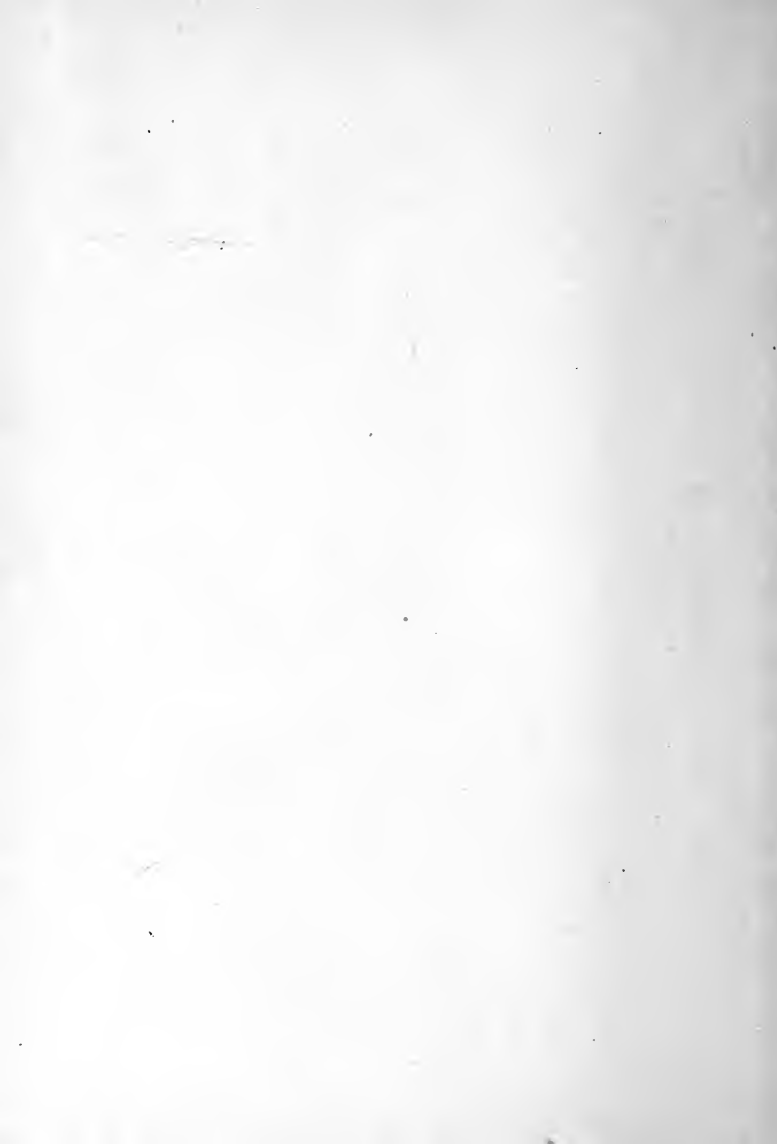
INDEX—Continued

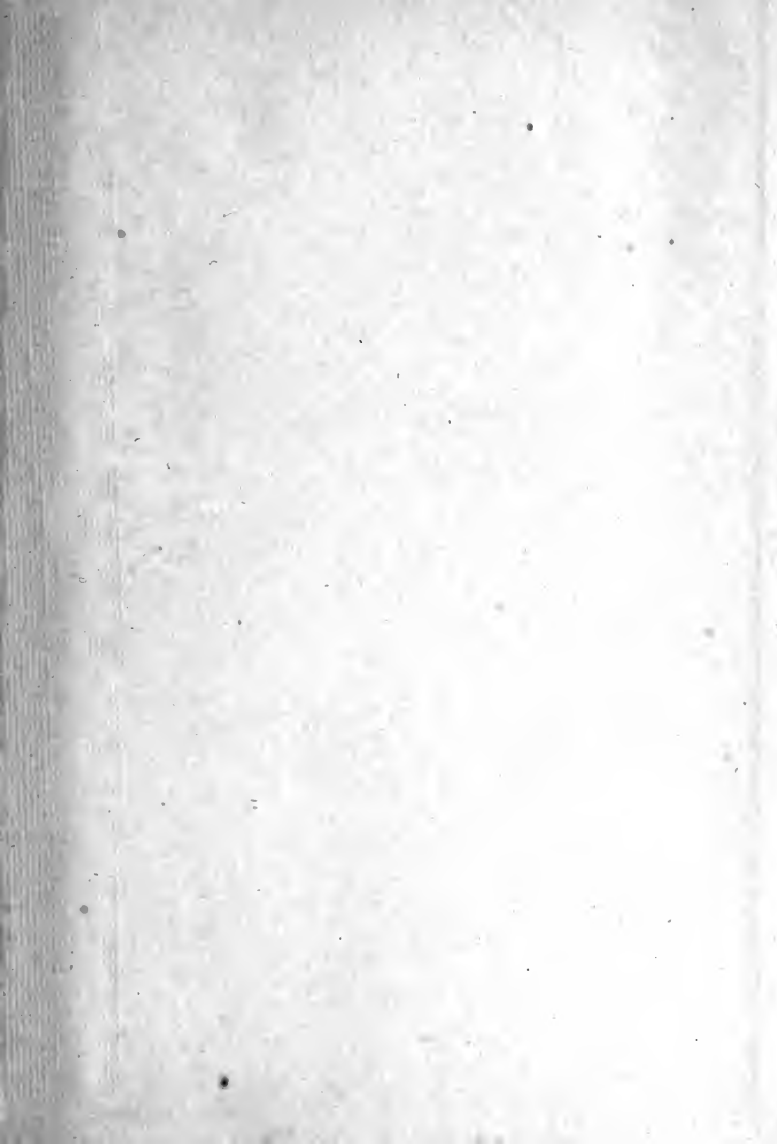
Rip Saw	77	Squaring Ends	69, 131, 144
Rounding Edges	113	Stain	12
Round Head Screws	9	Straight Edge	31, 32
Rule	44	Steel Framing Square	29
Sandpapering	95, 96, 102, 103	Stropping Plane Bit	91
Sandpaper	97	Superposition	157
Sandpaper Block	104	Surfacer	16
Saw	60	Swing Board	121
Sawing	60, 63, 78, 112	Table	243
Sawing End of Cylinder	223	Taboret	130, 139, 142, 162, 233, 236
Scale	57	Tapering	178
Scouring Box	191	Tearing Sandpaper	97
Scraping	127, 129	Testing 28, 30, 41, 56, 158, 161, 245	
Screen	183	Thread Screen	181
Screws	9	Towel Roller	223
Screw Driver	10	Trysquare	28, 73, 109, 174
Setting Gauge	44, 124	Umbrella Rack	179, 180, 240
Setting Nail	84	Varnishing	12
Setting Trysquare	55	Wire Edge	89
Sharpening Plane	86	Wagon Box	215
Shelf	114, 117, 119	Waste Paper Basket	201, 203
Shellac	11	Weaving	161
Shellacing	190	Whisk Broom Holder	195
Shoe Box	229	White Shellac	11
Sighting Bottom of Plane	21	Whittling	152, 154
Sighting Lengthwise	30	Whetting Plane Bit	87
Sighting for Wind	34	Wind	34
Sled	246	Withdrawing Nail	85
Smooth Plane	19	Work Basket	206

JUN 10 1912









LIBRARY OF CONGRESS



0 013 974 077 4